

Sequential Circuit Design: Principle

Outline

1. Overview on sequential circuits
2. Synchronous circuits
3. Danger of synthesizing asynchronous circuit
4. Inference of basic memory elements
5. Simple design examples
6. Timing analysis
7. Alternative one-segment coding style
8. Use of variable for sequential circuit

1. Overview on sequential circuit

- Combinational vs sequential circuit
 - Sequential circuit: output is a function of current input and state (memory)
- Basic memory elements
 - D latch
 - D FF (Flip-Flop)
 - RAM
- Synchronous vs asynchronous circuit

- D latch: level sensitive
- D FF: edge sensitive



(a) D latch

clk	q*
0	q
1	q
f	d

(b) pos-edge triggered D FF

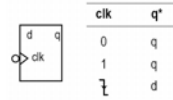

(c) neg-edge triggered D FF

reset	clk	q*
1	-	0
0	0	q
0	1	q
0	f	d

(d) D FF with asynchronous reset

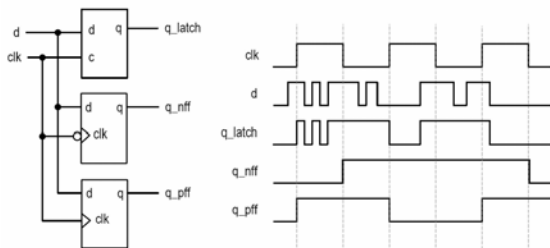

- Problem wit D latch:
Can the two D latches swap data?

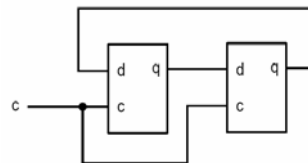

- Timing of a D FF:
 - Clock-to-q delay
 - Constraint: setup time and hold time

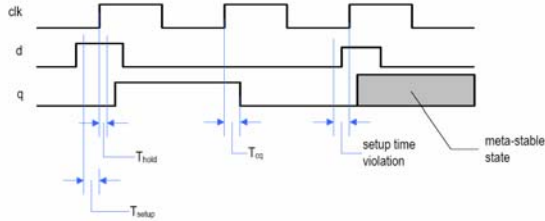

Sync vs asynch circuits

- Globally synchronous circuit: all memory elements (D FFs) controlled (synchronized) by a common global clock signal
- Globally asynchronous but locally synchronous circuit (GALS).
- Globally asynchronous circuit
 - Use D FF but not a global clock
 - Use no clock signal

2. Synchronous circuit

- One of the most difficult design aspects of a sequential circuit:
How to satisfy the timing constraints
- The Big idea: Synchronous methodology
 - Group all D FFs together with a single clock: Synchronous methodology
 - Only need to deal with the timing constraint of one memory element

- Basic block diagram
 - State register (memory elements)
 - Next-state logic (combinational circuit)
 - Output logic (combinational circuit)
- Operation
 - At the rising edge of the clock, state_next sampled and stored into the register (and becomes the new value of state_reg)
 - The next-state logic determines the new value (new state_next) and the output logic generates the output
 - At the rising edge of the clock, the new value of state_next sampled and stored into the register
- Glitches has no effects as long as the state_next is stabled at the sampling edge

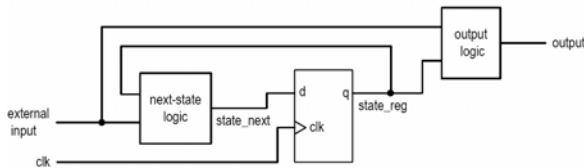

Sync circuit and EDA

- Synthesis: reduce to combinational circuit synthesis
- Timing analysis: involve only a single closed feedback loop (others reduce to combinational circuit analysis)
- Simulation: support "cycle-based simulation"
- Testing: can facilitate scan-chain

Types of sync circuits

- Not formally defined, Just for coding
- Three types:
 - “Regular” sequential circuit
 - “Random” sequential circuit (FSM)
 - “Combined” sequential circuit (FSM with a Data path, FSMFD)

3. Danger of synthesizing asynchronous circuit

- D Latch/DFF
 - Are combinational circuits with feedback loop
 - Design is different from normal combinational circuits (it is delay-sensitive)
 - Should not be synthesized from scratch
 - Should use pre-designed cells from device library

E.g., a D latch from scratch

		c	q'
d	q	0	q
		1	d

(a) D latch

```

library ieee;
use ieee.std_logic_1164.all;
entity dlatch is
    port(
        c: in std_logic;
        d: in std_logic;
        q: out std_logic
    );
end dlatch;
architecture demo_arch of dlatch is
    signal q_latch: std_logic;
begin
    process (c, d, q_latch)
    begin
        if (c='1') then
            q_latch <= d;
        else
            q_latch <= q_latch;
        end if;
    end process;
    q <= q_latch;
end demo_arch;
    
```

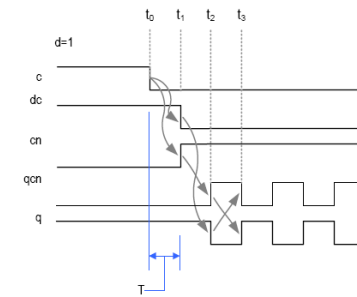
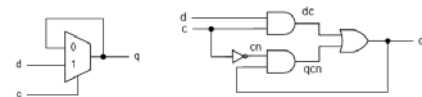

4. Inference of basic memory elements

- VHDL code should be clear so that the pre-designed cells can be inferred
- VHDL code
 - D Latch
 - Positive edge-triggered D FF
 - Negative edge-triggered D FF
 - D FF with asynchronous reset

D Latch

- No else branch
- D latch will be inferred

		c	q'
d	q	0	q
		1	d

(a) D latch

```

library ieee;
use ieee.std_logic_1164.all;
entity dlatch is
    port(
        c: in std_logic;
        d: in std_logic;
        q: out std_logic
    );
end dlatch;
architecture arch of dlatch is
begin
    process (c, d)
    begin
        if (c='1') then
            q <= d;
        end if;
    end process;
end arch;
    
```

Pos edge-triggered D FF

- No else branch
- Note the sensitivity list

clk	q'
0	q
1	q
f	d

(b) pos-edge triggered D FF

```

library ieee;
use ieee.std_logic_1164.all;
entity dff is
    port(
        clk: in std_logic;
        d: in std_logic;
        q: out std_logic
    );
end dff;
architecture arch of dff is
begin
    process (clk)
    begin
        if (clk'event and clk='1') then
            q <= d;
        end if;
    end process;
end arch;
    
```

• Neg edge-triggered D FF

clk	q'
0	q
1	q
f	d

```

if (clk'event and clk='0') then
    
```

D FF with async reset

- No else branch
- Note the sensitivity list

reset	clk	q'
1	-	0
0	0	q
0	1	q
0	f	d

```

library ieee;
use ieee.std_logic_1164.all;
entity dffr is
    port(
        clk: in std_logic;
        reset: in std_logic;
        d: in std_logic;
        q: out std_logic
    );
end dffr;
architecture arch of dffr is
begin
    process (clk,reset)
    begin
        if (reset='1') then
            q <='0';
        elsif (clk'event and clk='1') then
            q <= d;
        end if;
    end process;
end arch;
    
```

Register

- Multiple D FFs with same clock and reset

```

library ieee;
use ieee.std_logic_1164.all;
entity reg8 is
    port(
        clk: in std_logic;
        reset: in std_logic;
        d: in std_logic_vector(7 downto 0);
        q: out std_logic_vector(7 downto 0)
    );
end reg8;
architecture arch of reg8 is
begin
    process (clk,reset)
    begin
        if (reset='1') then
            q <=(others=>'0');
        elsif (clk'event and clk='1') then
            q <= d;
        end if;
    end process;
end arch;
    
```

5. Simple design examples

- Follow the block diagram
 - Register
 - Next-state logic (combinational circuit)
 - Output logic (combinational circuit)

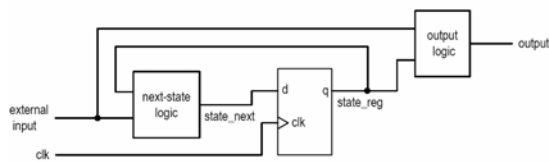

D FF with sync enable

- Note that the en is controlled by clock
- Note the sensitivity list

reset	clk	en	q'
1	-	-	0
0	0	-	q
0	1	-	q
0	f	0	q
0	f	1	d

(a) Function table

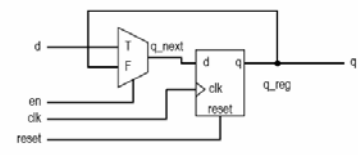

(b) Conceptual diagram

```

library ieee;
use ieee.std_logic_1164.all;
entity dff_en is
  port(
    clk: in std_logic;
    reset: in std_logic;
    en: in std_logic;
    d: in std_logic;
    q: out std_logic
  );
end dff_en;

```

```

architecture two_seg_arch of dff_en is
  signal q_reg: std_logic;
  signal q_next: std_logic;
begin
  -- a D FF
  process (clk,reset)
  begin
    if (reset='1') then
      q_reg <= '0';
    elsif (clk'event and clk='1') then
      q_reg <= q_next;
    end if;
  end process;
  -- next-state logic
  q_next <= d when en='1' else
    q_reg;
  -- output logic
  q <= q_reg;
end two_seg_arch;

```

T FF

reset	clk	t	q'
1	-	-	0
0	0	-	q
0	1	-	q
0	f	0	q
0	f	1	q'

(a) Function table

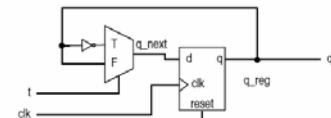

(b) Conceptual diagram

```

library ieee;
use ieee.std_logic_1164.all;
entity tff is
  port(
    clk: in std_logic;
    reset: in std_logic;
    t: in std_logic;
    q: out std_logic
  );
end tff;

architecture two_seg_arch of tff is
  signal q_reg: std_logic;
  signal q_next: std_logic;

```

```

architecture two_seg_arch of tff is
  signal q_reg: std_logic;
  signal q_next: std_logic;
begin
  -- a D FF
  process (clk,reset)
  begin
    if (reset='1') then
      q_reg <= '0';
    elsif (clk'event and clk='1') then
      q_reg <= q_next;
    end if;
  end process;
  -- next-state logic
  q_next <= q_reg when t='0' else
    not(q_reg);
  -- output logic
  q <= q_reg;
end two_seg_arch;

```

Free-running shift register

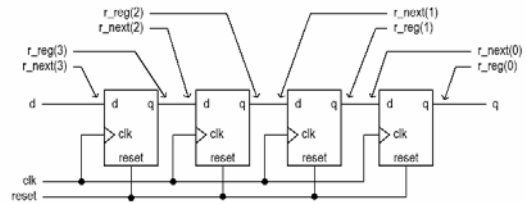

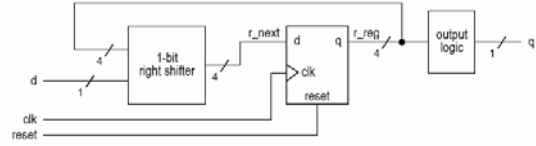
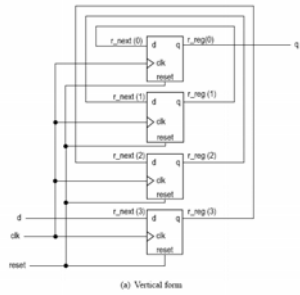

```

library ieee;
use ieee.std_logic_1164.all;
entity shift_right_register is
  port(
    clk, reset: in std_logic;
    d: in std_logic;
    q: out std_logic;
  end shift_right_register;

architecture two_seg_arch of shift_right_register is
  signal r_reg: std_logic_vector(3 downto 0);
  signal r_next: std_logic_vector(3 downto 0);
begin
  -- register
  process (clk, reset)
  begin
    if (reset='1') then
      r_reg <= (others=>'0');
    elsif (clk'event and clk='1') then
      r_reg <= r_next;
    end if;
  end process;
  -- next-state logic (shift right 1 bit)
  r_next <= d & r_reg(3 downto 1);
  -- output
  q <= r_reg(0);
end two_seg_arch;

```

```

library ieee;
use ieee.std_logic_1164.all;
entity shift_register is
  port(
    clk, reset: in std_logic;
    ctrl: in std_logic_vector(1 downto 0);
    d: in std_logic_vector(3 downto 0);
    q: out std_logic_vector(3 downto 0);
  end shift_register;

architecture two_seg_arch of shift_register is
  signal r_reg: std_logic_vector(3 downto 0);
  signal r_next: std_logic_vector(3 downto 0);

```

Universal shift register

- 4 ops: parallel load, shift right, shift left, pause

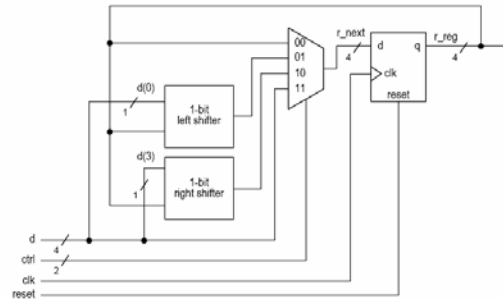

```

begin
  -- register
  process (clk, reset)
  begin
    if (reset='1') then
      r_reg <= (others=>'0');
    elsif (clk'event and clk='1') then
      r_reg <= r_next;
    end if;
  end process;
  -- next-state logic
  with ctrl select
    r_next <=
      r_reg when "00", --no op
      r_reg(2 downto 0) & d(0) when "01", --shift left;
      d(3) & r_reg(3 downto 1) when "10", --shift right;
      d when others;
  -- output
  q <= r_reg;
end two_seg_arch;

```

Arbitrary sequence counter

input pattern	output pattern
000	011
011	110
110	101
101	111
111	000

```
entity arbi_seq_counter4 is
  port(
    clk, reset: in std_logic;
    q: out std_logic_vector(2 downto 0)
  );
end arbi_seq_counter4;

architecture two_seg_arch of arbi_seq_counter4 is
  signal r_reg: std_logic_vector(2 downto 0);
  signal r_next: std_logic_vector(2 downto 0);
  ...
end two_seg_arch;
```

RTL Hardware Design
by P. Chu

Chapter 8

37

```
begin
  -- register
  process (clk, reset)
  begin
    if (reset='1') then
      r_reg <= (others=>'0');
    elsif (clk'event and clk='1') then
      r_reg <= r_next;
    end if;
  end process;
  -- next-state logic
  r_next <= "011" when r_reg="000" else
    "110" when r_reg="011" else
    "101" when r_reg="110" else
    "111" when r_reg="101" else
    "000"; -- r_reg="111"
  -- output logic
  q <= std_logic_vector(r_reg);
end two_seg_arch;
```

RTL Hardware Design
by P. Chu

Chapter 8

38

Free-running binary counter

- Count in binary sequence
- With a max_pulse output: asserted when counter is in "11...11" state

```
library ieee;
use ieee.std_logic_1164.all;
use ieee.numeric_std.all;
entity binary_counter4_pulse is
  port(
    clk, reset: in std_logic;
    max_pulse: out std_logic;
    q: out std_logic_vector(3 downto 0)
  );
end binary_counter4_pulse;
```

RTL Hardware Design
by P. Chu

Chapter 8

39

```
architecture two_seg_arch of binary_counter4_pulse is
  signal r_reg: unsigned(3 downto 0);
  signal r_next: unsigned(3 downto 0);
begin
  -- register
  process (clk, reset)
  begin
    if (reset='1') then
      r_reg <= (others=>'0');
    elsif (clk'event and clk='1') then
      r_reg <= r_next;
    end if;
  end process;
  -- next-state logic
  r_next <= r_reg + 1;
  -- output logic
  q <= std_logic_vector(r_reg);
  max_pulse <= '1' when r_reg="1111" else
    '0';
end two_seg_arch;
```

RTL Hardware Design
by P. Chu

Chapter 8

40

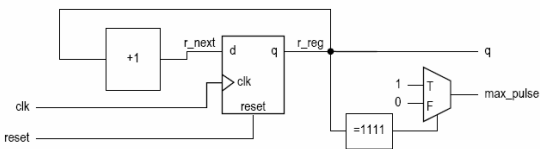

- Wrapped around automatically
- Poor practice:

```
r_next <= (r_reg + 1) mod 16;
```

RTL Hardware Design
by P. Chu

Chapter 8

41

Binary counter with bells & whistles

syn_clr	load	en	q*	operation
1	-	-	00...00	synchronous clear
0	1	-	d	parallel load
0	0	1	q+1	count
0	0	0	q	pause

```
library ieee;
use ieee.std_logic_1164.all;
use ieee.numeric_std.all;
entity binary_counter4_feature is
  port(
    clk, reset: in std_logic;
    syn_clr, en, load: std_logic;
    d: std_logic_vector(3 downto 0);
    q: out std_logic_vector(3 downto 0)
  );
end binary_counter4_feature;
```

RTL Hardware Design
by P. Chu

Chapter 8

42

```

architecture two_seg_arch of binary_counter4_feature is
    signal r_reg: unsigned(3 downto 0);
    signal r_next: unsigned(3 downto 0);
begin
    -- register
    process (clk,reset)
    begin
        if (reset='1') then
            r_reg <= (others=>'0');
        elsif (clk'event and clk='1') then
            r_reg <= r_next;
        end if;
    end process;
    -- next-state logic
    r_next <= (others=>'0') when syn_clr='1' else
        unsigned(d) when load='1' else
        r_reg + 1 when en='1' else
        r_reg;
    -- output logic
    q <= std_logic_vector(r_reg);
end two_seg_arch;

```

RTL Hardware Design
by P. Chu

Chapter 8

43

Decade (mod-10) counter

```

architecture two_seg_arch of mod10_counter is
    constant TEN: integer := 10;
    signal r_reg: unsigned(3 downto 0);
    signal r_next: unsigned(3 downto 0);
begin
    -- register
    process (clk,reset)
    begin
        if (reset='1') then
            r_reg <= (others=>'0');
        elsif (clk'event and clk='1') then
            r_reg <= r_next;
        end if;
    end process;
    -- next-state logic
    r_next <= (others=>'0') when r_reg=(TEN-1) else
        r_reg + 1;
    -- output logic
    q <= std_logic_vector(r_reg);
end two_seg_arch;

```

RTL Hardware Design
by P. Chu

Chapter 8

44

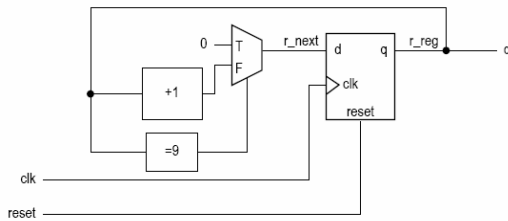

RTL Hardware Design
by P. Chu

Chapter 8

45

Programmable mod-m counter

```

library ieee;
use ieee.std_logic_1164.all;
use ieee.numeric_std.all;
entity prog_counter is
    port(
        clk, reset: in std_logic;
        m: in std_logic_vector(3 downto 0);
        q: out std_logic_vector(3 downto 0)
    );
end prog_counter;

architecture two_seg_clear_arch of prog_counter is

```

RTL Hardware Design
by P. Chu

Chapter 8

46

```

    signal r_reg: unsigned(3 downto 0);
    signal r_next: unsigned(3 downto 0);
begin
    -- register
    process (clk,reset)
    begin
        if (reset='1') then
            r_reg <= (others=>'0');
        elsif (clk'event and clk='1') then
            r_reg <= r_next;
        end if;
    end process;
    -- next-state logic
    r_next <= (others=>'0') when r_reg=(unsigned(m)-1) else
        r_reg + 1;
    -- output logic
    q <= std_logic_vector(r_reg);
end two_seg_clear_arch;

```

RTL Hardware Design
by P. Chu

Chapter 8

47

```

architecture two_seg_effi_arch of prog_counter is
    signal r_reg: unsigned(3 downto 0);
    signal r_next, r_inc: unsigned(3 downto 0);
begin
    -- register
    process (clk,reset)
    begin
        if (reset='1') then
            r_reg <= (others=>'0');
        elsif (clk'event and clk='1') then
            r_reg <= r_next;
        end if;
    end process;
    -- next-state logic
    r_inc <= r_reg + 1;
    r_next <= (others=>'0') when r_inc=unsigned(m) else
        r_inc;
    -- output logic
    q <= std_logic_vector(r_reg);
end two_seg_effi_arch;

```

RTL Hardware Design
by P. Chu

Chapter 8

48

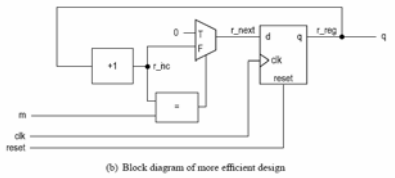
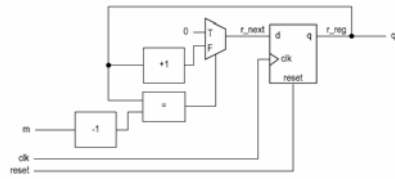

6. Timing analysis

- Combinational circuit:
 - characterized by propagation delay
- Sequential circuit:
 - Has to satisfy setup/hold time constraint
 - Characterized by maximal clock rate (e.g., 200 MHz counter, 2.4 GHz Pentium II)
 - Setup time and clock-to-q delay of register and the propagation delay of next-state logic are embedded in clock rate

- state_next must satisfy the constraint
- Must consider effect of
 - state_reg: can be controlled
 - synchronized external input (from a subsystem of same clock)
 - unsynchronized external input
- Approach
 - First 2: adjust clock rate to prevent violation
 - Last: use “synchronization circuit” to resolve violation

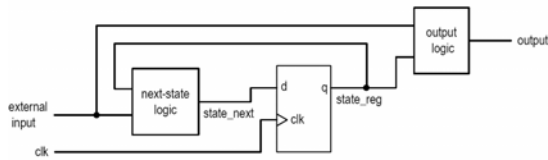

- Setup time violation and maximal clock rate

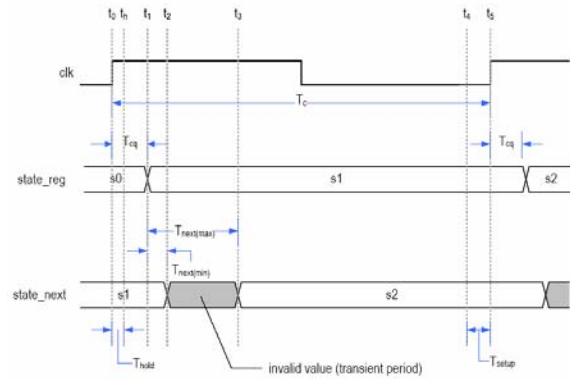

$$t_3 = t_0 + T_{cq} + T_{next(max)}$$

$$t_4 = t_5 - T_{setup} = t_0 + T_c - T_{setup}$$

$$t_3 < t_4$$

$$t_0 + T_{cq} + T_{next(max)} < t_0 + T_c - T_{setup}$$

$$T_{cq} + T_{next(max)} + T_{setup} < T_c$$

$$T_{c(min)} = T_{cq} + T_{next(max)} + T_{setup}$$

- E.g., shift register; let $T_{cq}=1.0ns$ $T_{setup}=0.5ns$

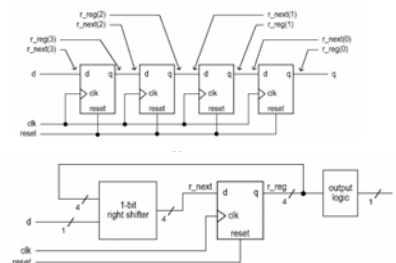

$$T_{c(min)} = T_{cq} + T_{setup} = 1.5 ns$$

$$f_{max} = \frac{1}{T_{cq} + T_{setup}} = \frac{1}{1.5 ns} \approx 666.7 MHz$$

- E.g., Binary counter; let $T_{cq}=1.0\text{ns}$ $T_{setup}=0.5\text{ns}$

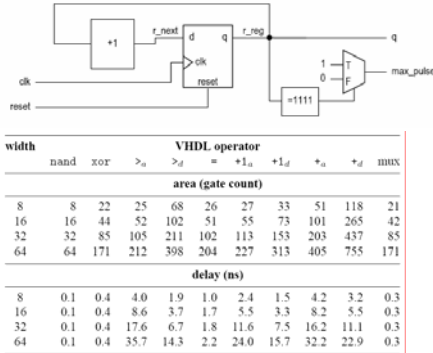

$$f_{max} = \frac{1}{T_{cq} + T_{8_bit_inc(area)} + T_{setup}} = \frac{1}{1\text{ ns} + 2.4\text{ ns} + 0.5\text{ ns}} \approx 256.4\text{ MHz}$$

$$f_{max} = \frac{1}{T_{cq} + T_{16_bit_inc(area)} + T_{setup}} = \frac{1}{1\text{ ns} + 5.5\text{ ns} + 0.5\text{ ns}} \approx 142.9\text{ MHz}$$

$$f_{max} = \frac{1}{T_{cq} + T_{32_bit_inc(area)} + T_{setup}} = \frac{1}{1\text{ ns} + 11.6\text{ ns} + 0.5\text{ ns}}$$

$$f_{max} = \frac{1}{T_{cq} + T_{8_bit_inc(delay)} + T_{setup}} = \frac{1}{1\text{ ns} + 1.5\text{ ns} + 0.5\text{ ns}} \approx 333.3\text{ MHz}$$

$$f_{max} = \frac{1}{T_{cq} + T_{16_bit_inc(delay)} + T_{setup}} = \frac{1}{1\text{ ns} + 3.3\text{ ns} + 0.5\text{ ns}} \approx 208.3\text{ MHz}$$

and

$$f_{max} = \frac{1}{T_{cq} + T_{32_bit_inc(delay)} + T_{setup}} = \frac{1}{1\text{ ns} + 7.5\text{ ns} + 0.5\text{ ns}} \approx 111.1\text{ MHz}$$

- Hold time violation

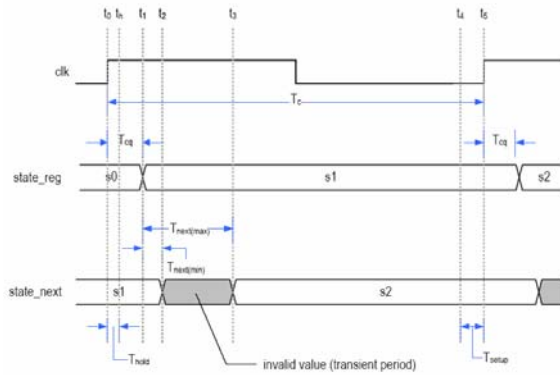

$$t_2 = t_0 + T_{cq} + T_{next(min)}$$

$$t_h = t_0 + T_{hold}$$

$$t_h < t_2$$

$$T_{hold} < T_{cq} + T_{next(min)}$$

$$T_{hold} < T_{cq}$$

Output delay

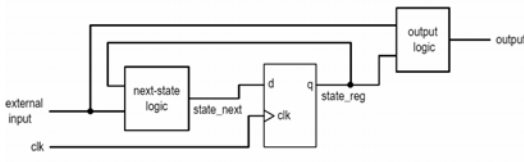

$$T_{co} = T_{cq} + T_{output}$$

7. Alternative one-segment coding style

- Combine register and next-state logic/output logic in the same process
- May appear compact for certain simple circuit
- But it can be error-prone

D FF with sync enable

reset	clk	en	q [*]
1	-	-	0
0	0	-	q
0	1	-	q
0	f	0	q
0	f	1	d

(a) Function table

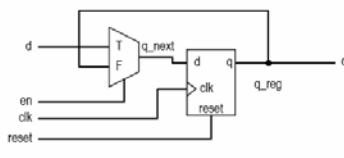

(b) Conceptual diagram

```

library ieee;
use ieee.std_logic_1164.all;
entity dff_en is
    port(
        clk: in std_logic;
        reset: in std_logic;
        en: in std_logic;
        d: in std_logic;
        q: out std_logic
    );
end dff_en;
    
```

```

architecture two_seg_arch of dff_en is
    signal q_reg: std_logic;
    signal q_next: std_logic;
begin
    -- a D FF
    process (clk,reset)
    begin
        if (reset='1') then
            q_reg <= '0';
        elsif (clk'event and clk='1') then
            q_reg <= q_next;
        end if;
    end process;
    -- next-state logic
    q_next <= d when en='1' else
        q_reg;
    -- output logic
    q <= q_reg;
end two_seg_arch;
    
```

```

Architecture one_seg_arch of dff_en is
begin
    process (clk,reset)
    begin
        if (reset='1') then
            q <= '0';
        elsif (clk'event and clk='1') then
            if (en='1') then
                q <= d;
            end if;
        end if;
    end process;
end one_seg_arch;
    
```

- Interpretation: any left-hand-side signal within the clk'event and clk='1' branch infers a D FF

T FF

reset	clk	t	q [*]
1	-	-	0
0	0	-	q
0	1	-	q
0	f	0	q
0	f	1	q'

(a) Function table

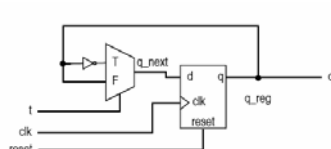

(b) Conceptual diagram

```

library ieee;
use ieee.std_logic_1164.all;
entity tff is
    port(
        clk: in std_logic;
        reset: in std_logic;
        t: in std_logic;
        q: out std_logic
    );
end tff;
    
```

```

architecture two_seg_arch of tff is
    signal q_reg: std_logic;
    signal q_next: std_logic;
    
```

```

architecture two_seg_arch of tff is
  signal q_reg: std_logic;
  signal q_next: std_logic;
begin
  -- a D FF
  process (clk,reset)
  begin
    if (reset='1') then
      q_reg <= '0';
    elsif (clk'event and clk='1') then
      q_reg <= q_next;
    end if;
  end process;
  -- next-state logic
  q_next <= q_reg when t='0' else
    not(q_reg);
  -- output logic
  q <= q_reg;
end two_seg_arch;

```

RTL Hardware Design Chapter 8
by P. Chu

67

```

architecture one_seg_arch of tff is
  signal q_reg: std_logic;
begin
  process (clk, reset)
  begin
    if reset='1' then
      q_reg <= '0';
    elsif (clk'event and clk='1') then
      if (t='1') then
        q_reg <= not q_reg;
      end if;
    end process;
    q <= q_reg;
  end one_seg_arch;.

```

RTL Hardware Design Chapter 8
by P. Chu

68

Binary counter with bells & whistles

syn_clr	load	en	q*	operation
1	-	-	00...00	synchronous clear
0	1	-	d	parallel load
0	0	1	q+1	count
0	0	0	q	pause

```

library ieee;
use ieee.std_logic_1164.all;
use ieee.numeric_std.all;
entity binary_counter4_feature is
  port(
    clk, reset: in std_logic;
    syn_clr, en, load: std_logic;
    d: std_logic_vector(3 downto 0);
    q: out std_logic_vector(3 downto 0)
  );
end binary_counter4_feature;

```

RTL Hardware Design Chapter 8
by P. Chu

69

```

architecture two_seg_arch of binary_counter4_feature is
  signal r_reg: unsigned(3 downto 0);
  signal r_next: unsigned(3 downto 0);
begin
  -- register
  process (clk,reset)
  begin
    if (reset='1') then
      r_reg <= (others=>'0');
    elsif (clk'event and clk='1') then
      r_reg <= r_next;
    end if;
  end process;
  -- next-state logic
  r_next <= (others=>'0') when syn_clr='1' else
    unsigned(d) when load='1' else
      r_reg + 1 when en='1' else
      r_reg;
  -- output logic
  q <= std_logic_vector(r_reg);
end two_seg_arch;

```

RTL Hardware Design Chapter 8
by P. Chu

70

```

architecture one_seg_arch of binary_counter4_feature is
  signal r_reg: unsigned(3 downto 0);
  signal r_next: unsigned(3 downto 0);
begin
  -- register & next-state logic
  process (clk,reset)
  begin
    if (reset='1') then
      r_reg <= (others=>'0');
    elsif (clk'event and clk='1') then
      if syn_clr='1' then
        r_reg <= (others=>'0');
      elsif load='1' then
        r_reg <= unsigned(d);
      elsif en='1' then
        r_reg <= r_reg + 1;
      end if;
    end if;
  end process;
  -- output logic
  q <= std_logic_vector(r_reg);
end one_seg_arch;

```

RTL Hardware Design Chapter 8
by P. Chu

Free-running binary counter

- Count in binary sequence
- With a max_pulse output: asserted when counter is in "11...11" state

```

library ieee;
use ieee.std_logic_1164.all;
use ieee.numeric_std.all;
entity binary_counter4_pulse is
  port(
    clk, reset: in std_logic;
    max_pulse: out std_logic;
    q: out std_logic_vector(3 downto 0)
  );
end binary_counter4_pulse;

```

RTL Hardware Design Chapter 8
by P. Chu

72

```

architecture two_seg_arch of binary_counter4_pulse is
    signal r_reg: unsigned(3 downto 0);
    signal r_next: unsigned(3 downto 0);
begin
    -- register
    process (clk,reset)
    begin
        if (reset='1') then
            r_reg <= (others=>'0');
        elsif (clk'event and clk='1') then
            r_reg <= r_next;
        end if;
    end process;
    -- next-state logic
    r_next <= r_reg + 1;
    -- output logic
    q <= std_logic_vector(r_reg);
    max_pulse <= '1' when r_reg="1111" else
        '0';
end two_seg_arch;

```

RTL Hardware Design
by P. Chu

Chapter 8

73

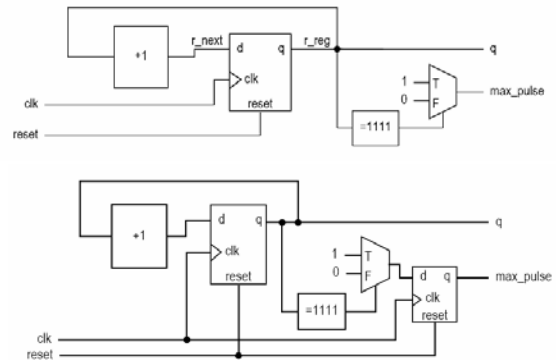

RTL Hardware Design
by P. Chu

Chapter 8

74

```

architecture not_work_one_seg_glitch_arch
    of binary_counter4_pulse is
    signal r_reg: unsigned(3 downto 0);
begin
    process (clk,reset)
    begin
        if (reset='1') then
            r_reg <= (others=>'0');
        elsif (clk'event and clk='1') then
            r_reg <= r_reg + 1;
            if r_reg="1111" then
                max_pulse <= '1';
            else
                max_pulse <= '0';
            end if;
        end if;
    end process;
    q <= std_logic_vector(r_reg);
end not_work_one_seg_glitch_arch;

```

75

```

architecture work_one_seg_glitch_arch
    of binary_counter4_pulse is
    signal r_reg: unsigned(3 downto 0);
begin
    process (clk,reset)
    begin
        if (reset='1') then
            r_reg <= (others=>'0');
        elsif (clk'event and clk='1') then
            r_reg <= r_reg + 1;
        end if;
    end process;
    q <= std_logic_vector(r_reg);
    max_pulse <= '1' when r_reg="1111" else
        '0';
end work_one_seg_glitch_arch;

```

RTL Hardware Design
by P. Chu

Chapter 8

76

Programmable mod-m counter

```

library ieee;
use ieee.std_logic_1164.all;
use ieee.numeric_std.all;
entity prog_counter is
    port(
        clk, reset: in std_logic;
        m: in std_logic_vector(3 downto 0);
        q: out std_logic_vector(3 downto 0)
    );
end prog_counter;

architecture two_seg_clear_arch of prog_counter is

```

RTL Hardware Design
by P. Chu

Chapter 8

77

```

architecture two_seg_effi_arch of prog_counter is
    signal r_reg: unsigned(3 downto 0);
    signal r_next, r_inc: unsigned(3 downto 0);
begin
    -- register
    process (clk,reset)
    begin
        if (reset='1') then
            r_reg <= (others=>'0');
        elsif (clk'event and clk='1') then
            r_reg <= r_next;
        end if;
    end process;
    -- next-state logic
    r_inc <= r_reg + 1;
    r_next <= (others=>'0') when r_inc=unsigned(m) else
        r_inc;
    -- output logic
    q <= std_logic_vector(r_reg);
end two_seg_effi_arch;

```

RTL Hardware Design
by P. Chu

Chapter 8

78

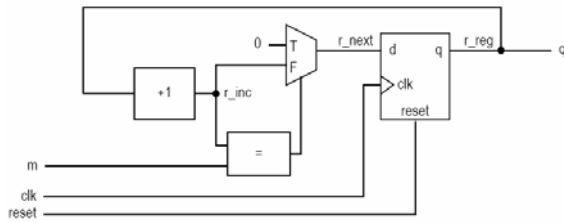

```
architecture not_work_one_arch of prog_counter is
    signal r_reg: unsigned(3 downto 0);
begin
    process (clk,reset)
    begin
        if reset='1' then
            r_reg <= (others=>'0');
        elsif (clk'event and clk='1') then
            r_reg <= r_reg+1;
            if (r_reg=unsigned(m)) then
                r_reg <= (others=>'0');
            end if;
        end if;
    end process;
    q <= std_logic_vector(r_reg);
end not_work_one_arch;
```

```
architecture work_one_arch of prog_counter is
    signal r_reg: unsigned(3 downto 0);
    signal r_inc: unsigned(3 downto 0);
begin
    process (clk,reset)
    begin
        if reset='1' then
            r_reg <= (others=>'0');
        elsif (clk'event and clk='1') then
            if (r_inc=unsigned(m)) then
                r_reg <= (others=>'0');
            else
                r_reg <= r_inc;
            end if;
        end process;
        r_inc <= r_reg + 1;
        q <= std_logic_vector(r_reg);
    end work_one_arch;
```

- Two-segment code
 - Separate memory segment from the rest
 - Can be little cumbersome
 - Has a clear mapping to hardware component
- One-segment code
 - Mix memory segment and next-state logic / output logic
 - Can sometimes be more compact
 - No clear hardware mapping
 - Error prone
- Two-segment code is preferred