



**Rapid Prototyping of
Application-Specific Signal Processors
(RASSP)**

CAD SYSTEM DESCRIPTION

BASELINE 2.0

CDRL A007

Contract Number: DAAL01-93-C-3380

June 1998



Lockheed Martin
Advanced Technology Laboratories

Rapid Prototyping of Application-Specific Signal Processors (RASSP)

CAD SYSTEM DESCRIPTION

BASELINE 2.0

CDRL A007

Contract Number: DAAL01-93-C-3380

Submitted By:

Lockheed Martin RASSP Team
Lockheed Martin Advanced Technology Laboratories
Building A&E 2W
1 Federal Street
Camden, NJ 08102

For further information contact:

Mr. Dennis Basara
Telephone: 609-338-2545
Fax: 609-338-4155
E-mail: dbasara@atl.lmco.com

June 1998

TABLE OF CONTENTS

1.	Introduction	1-1
1.1	RASSP Baseline 2 CAD System Overview	1-1
1.1.1	System Design Tools (System Definition)	1-2
1.1.2	Hardware/Software Co-Design CAE Tools (Architecture Definition Process)	1-2
1.1.3	Hardware Design Tools	1-3
1.1.4	Design-For-Test Tools	1-4
1.1.5	Enterprise System Tools	1-6
1.2	Hardware for CAD Environment	1-7
2.	Systems Design Tools	2-1
2.1	Process Summary	2-1
2.2	Systems Design CAE Tools	2-1
2.2.1	Marconi Systems	2-2
2.2.1.1	RTM	2-2
2.2.2	Ascent Logic	2-4
2.2.2.1	RDD-100	2-4
2.2.3	Alta Group	2-7
2.2.3.1	BONeS	2-7
2.2.3.2	Signal Processing Worksystem (SPW)	2-7
2.2.4	Mathworks	2-7
2.2.4.1	MATLAB	2-7
2.2.5	MSI	2-8
2.2.5.1	RAM/ILS	2-8
2.2.6	Lockheed Martin ATL	2-9
2.2.6.1	GEDAE™	2-9
2.2.6.2	PRICE S/M/H/HL	2-10
2.2.7	Aspect Development	2-11
2.2.7.1	Explore (CLMS)	2-11
2.2.8	Interleaf	2-11
2.2.8.1	Technical Publishing Software (TPS)	2-11
2.3	System Design Tool Integration	2-12
2.3.1	RDD-100/PRICE/RAM-ILS Integration (RASSP Developed)	2-12
2.3.2	RTM/RDD-100 (Developed on LM EPI Program)	2-13
2.3.3	RDD-100 BONeS (Developed on LM EPI Program)	2-14
3.	Hardware/Software Co-Design Tools	3-1
3.1	Process Summary	3-1
3.2	Hardware/Software Co-Design CAE Tools	3-3
3.2.1	JRS Research Laboratories	3-4
3.2.1.1	NetSyn	3-4
3.2.2	Savantage, Inc.	3-4
3.2.2.1	SavanSys	3-4
3.2.3	BDTI/UC Berkeley	3-5
3.2.3.1	Ptolemy	3-5
3.2.4	Lockheed Martin ATL	3-5
3.2.4.1	GEDAE™	3-5
3.2.4.2	Application Interface Builder (AIB)	3-6
3.2.4.3	PRICE	3-6
3.2.5	Omniview/Honeywell	3-7
3.2.5.1	Performance Modeling Workbench (PMW)	3-7

3.2.6	Management Sciences Inc.	3-7
3.2.6.1	RAM-ILS	3-7
3.2.7	Marconi Systems	3-7
3.2.7.1	RTM	3-7
3.2.8	Alta Group	3-7
3.2.8.1	SPW	3-7
3.2.9	Mathworks	3-8
3.2.9.1	MATLAB	3-8
3.2.10	Precedence	3-8
3.2.10.1	SimMatrix	3-8
3.2.11	Mentor Graphics	3-8
3.2.11.1	QuickVHDL	3-8
3.2.12	MCCI	3-8
3.2.12.1	Autocoding Toolset	3-8
3.2.13	VERILOG	3-8
3.2.13.1	ObjectGEODE	3-8
3.2.14	Applied Dynamics International (ADI)	3-9
3.2.14.1	BEACON	3-9
3.2.15	Harris Electronic Design Automation	3-9
3.2.15.1	Harris EDAnavigator	3-9
3.2.16	Lucent	3-9
3.2.16.1	SPEAR	3-9
3.2.17	University Of Oregon	3-9
3.2.17.1	PIE (Performance Instrumentation Environment)	3-9
3.2.18	Ascent Logic	3-10
3.2.18.1	RDD-100	3-10
4.	Hardware Design Tools	4-1
4.1	Hardware Design Process Summary	4-1
4.2	Hardware Design CAE Tools	4-3
4.2.1	Mentor Graphics	4-4
4.2.1.1	Design Architect	4-4
4.2.1.2	QuickVHDL	4-6
4.2.1.3	Library Management System (LMS)	4-7
4.2.1.4	PLD Synthesis II	4-7
4.2.1.5	QuickPath	4-8
4.2.1.6	Board Designer	4-8
4.2.1.7	AutoTherm	4-10
4.2.1.8	MCM Station	4-10
4.2.2	Synopsys	4-10
4.2.2.1	VHDL Compiler	4-10
4.2.2.2	Design Compiler	4-10
4.2.2.3	DesignWare	4-11
4.2.2.4	SmartModel Library (Logic Modeling Group)	4-11
4.2.2.5	LM Family Hardware Modeler	4-11
4.2.2.6	VHDL Models (SourceModels)	4-13
4.2.3	NeoCAD	4-14
4.2.3.1	FPGA Foundry	4-14
4.2.4	Summit	4-14
4.2.4.1	TDS (Test Development Series)	4-14
4.2.4.2	Visual HDL	4-15
4.2.5	Precedence	4-15
4.2.5.1	SimMatrix	4-15

4.2.6	SDRC	4-15
4.2.6.1	Master Modeler	4-15
4.2.6.2	Sheet Metal Design	4-16
4.2.6.3	Drafting	4-16
4.2.6.4	Tolerance Analysis	4-16
4.2.6.5	Mechanism Design	4-16
4.2.6.6	View and Markup	4-16
4.2.6.7	Finite Element Modeling	4-16
4.2.6.8	Optimization	4-16
4.2.6.9	System Dynamics Analysis	4-17
4.2.7	Quickturn	4-17
4.2.7.1	System Realizer Family	4-17
4.2.8	VEDA Design Automation, Inc.	4-17
4.2.8.1	VHDLCover	4-17
4.2.9	Teradyne	4-17
4.2.9.1	VICTORY	4-17
4.2.10	Ascent Logic	4-18
4.2.10.1	RDD-100	4-18
4.2.11	Savantage	4-18
4.2.11.1	SavanSys	4-18
4.3	Hardware Design Tool Integration	4-18
4.3.1	Framework (Mentor's FALCON)	4-18
4.3.1.1	Common User Interface	4-19
4.3.1.2	Design Manager	4-19
4.3.1.3	BOLD Browser	4-19
4.3.1.4	Notepad	4-19
4.3.1.5	Decision Support System (DSS)	4-19
4.3.1.6	AMPLE	4-19
5.	Design-For-Test Tools	5-1
5.1	Process Description	5-1
5.2	Design-For-Test CAE Tools	5-3
5.2.1	Teradyne	5-4
5.2.1.1	VICTORY	5-4
5.2.1.2	LASAR	5-5
5.2.2	Naval Undersea Warfare Center	5-5
5.2.2.1	WSTA (Weapon System Testability Analyzer)	5-5
5.2.3	Detex Systems, Inc.	5-9
5.2.3.1	STAT (System Testability Analysis Tool)	5-9
5.2.4	Logic Vision Software	5-10
5.2.4.1	ASIC Test Tool Suite	5-10
5.2.5	Lockheed Martin ATL/Self Test Services	5-12
5.2.5.1	Test Strategy Diagram	5-12
5.2.6	ASSET, Inc.	5-15
5.2.6.1	ASSET Diagnostic System	5-15
5.2.7	Mentor/Teradyne	5-16
5.2.7.1	Virtual Test Manager: Testpoint Optimizer Software (VTM:TOP)	5-16
5.2.8	Rome Laboratory	5-17
5.2.8.1	TSTB WAVES	5-17
5.2.9	Summit	5-17
5.2.9.1	TDS (Test Development Series)	5-17
5.2.10	Mentor	5-18
5.2.10.1	FASTSCAN	5-18
5.2.10.2	QuickGrade	5-18
5.2.10.3	PTM:SITE	5-18

5.2.11	National Semiconductor	5-18
5.2.11.1	SCANease	5-18
5.2.12	Synopsys	5-18
5.2.12.1	Test Compiler	5-18
5.2.13	MSI Systems	5-19
5.2.13.1	STARS (Formerly DARTS)	5-19
5.2.14	Test Economic Services	5-20
5.2.14.1	Economic Modeling Tools	5-20
5.2.15	IKOS	5-20
5.2.15.1	Voyager FS	5-20
5.2.16	ZYCAD	5-20
5.2.16.1	Fault Simulation Accelerator	5-20
6.	Enterprise System Tools	6-1
6.1	Enterprise System Overview	6-1
6.2	Enterprise System Tools	6-1
6.2.1	Intergraph	6-2
6.2.1.1	Design Methodology Manager	6-2
6.2.1.2	Asset and Information Management (AIM)	6-3
6.2.2	Aspect	6-6
6.2.2.1	Explore (CLMS)	6-6
6.2.3	Sandpiper Software, Inc.	6-9
6.2.3.1	RASSP Reuse Data Manager (RRDM)	6-9
6.2.4	TriTeal	6-11
6.2.4.1	TriTeal Enterprise Desktop (TED)	6-11
6.2.5	SCRA	6-12
6.2.5.1	Manufacturing Interface	6-12
6.2.6	Insoft	6-13
6.2.6.1	Communiqué and Cooltalk	6-13
6.2.7	Netscape	6-15
6.2.7.1	Netscape Enterprise Server	6-15
6.2.8	Viacrypt	6-15
6.2.8.1	Pretty Good Privacy (PGP)	6-15
6.2.9	Mentor	6-15
6.2.9.1	WorkExpert	6-15
6.2.10	KBSI	6-17
6.2.10.1	ProSim	6-17
6.2.11	AT&T	6-18
6.2.11.1	WITNESS	6-18
6.2.12	Microsoft	6-18
6.2.12.1	MS Project	6-18
Appendix 1	RASSP Baseline 2.0 — CAD System Tools	A-1
	System Design	A-1
	Hardware/Software Co-Design	A-1
	Hardware Design	A-2
	Design-For-Test	A-3
	Enterprise System	A-4

LIST OF ILLUSTRATIONS

1.1-1	RASSP Design Environment—Baseline 2	1-1
2.2-1	RASSP Baseline 2 system design tools	2-2
2.2-2	RTM lifecycle support	2-3
2.2-3	RDD-100 supports requirements and functional analysis	2-5
2.2-4	Behavior diagram structures	2-6
2.3-1	RDD-100/PRICE/RAM-ILS integration	2-13
2.3-2	Overview of RTM/RDD-00 integration	2-14
2.3-3	Overview of RDD-100 BONEs integration	2-15
3.1-1	Software architecture	3-1
3.1-2	Architecture selection toolset	3-2
3.2-1	Application Interface Builder bridges gap between data flow and control flow	3-6
4.1-1	RASSP hardware design tools	4-1
4.2-1	Mentor IDEA EDA tool set	4-5
4.2-2	Design architect screen	4-6
4.2-3	Board designer process flow	4-9
4.2-4	LM Family usage in the design cycle	4-12
4.3-1	FALCON Framework components	4-18
5.2-1	WSTA role in IDSS	5-6
5.2-2	WSTA functional flow diagram	5-6
5.2-3	ASICTEST tool suite	5-11
5.2-4	Test strategy diagram concept	5-13
5.2-5	Hierarchy of test strategy diagrams	5-14
5.2-6	Typical requirements TSD	5-15
6.2-1	Search results screen	6-8
6.2-2	Sandpiper Software Intelligent Information Broker Context	6-10
6.2-3	RASSP manufacturing interface architecture	6-13
6.2-4	Supporting electronic commerce	6-14

LIST OF TABLES

2.2-1	RAM/ILS tool features	2-8
5-1	DFT Tool Gap	5-1

1. INTRODUCTION

Lockheed Martin ATL's design environment implementation team has leveraged the heritage of its Engineering Process Improvement (EPI) program to combine a proven set of tools with extended capabilities for Baseline 0. Enhancements have been made in tool integration, functionality, and performance in the CAD system for Baseline 1. Intergraph will provide a framework to integrate all tools and automate process and workflow control. An updated description of the Baseline 1 tools is the focus of this document and is referred to as Baseline 2. The tools are organized according to their use within the RASSP design methodology.

1.1 RASSP Baseline 2 CAD System Overview

A summary of the tools for systems, architecture, and detailed design (hardware and software) areas is provided in the following paragraphs. Appendix A gives a concise listing of the RASSP Baseline 2 tools. More detailed discussion of the features and use of each of these tools is given in the sections that follow. Some tools are used in more than one design area. The description of the tools will reflect the context in which they are used. Figure 1.1-1 shows an overview of all the tools used in the RASSP design process except the library tools and basic support tools such as compilers and text editors. The Design-For-Test (DFT) tools are also not shown since their use is integrated into many aspects of each design flow. The DFT tools are described in Section 1.1.4.

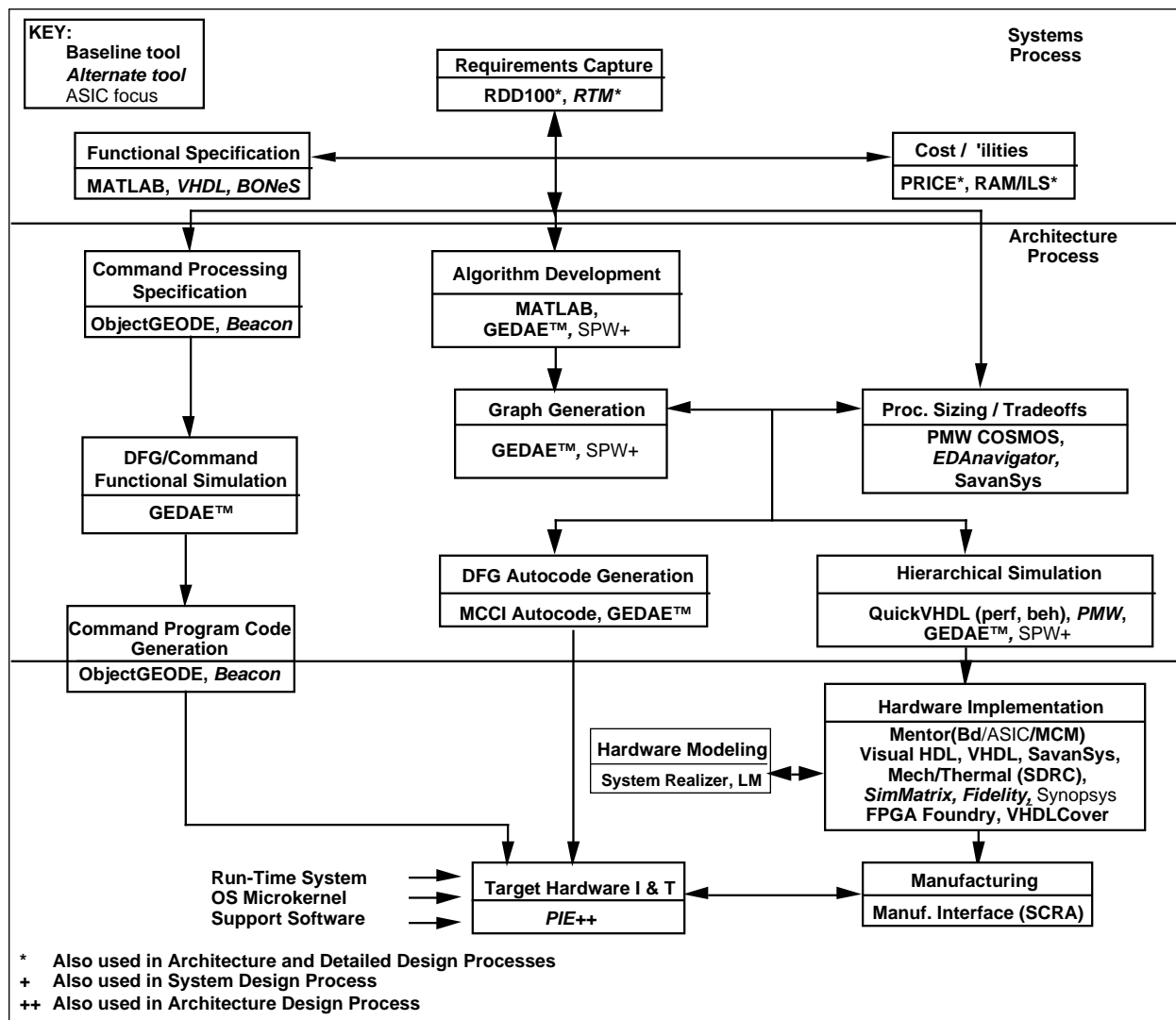

Figure 1.1-1. RASSP Design Environment—Baseline 2.

1.1.1 System Design Tools (System Definition)

The System design tools support early development of system partitioning, test, reliability, and maintenance concepts. These tools include the following:

- RTM (Requirements and Traceability Management) from Marconi Systems is used as the requirements traceability tool throughout a program's engineering life cycle.
- RDD-100 (Requirements Driven Development) from Ascent Logic is used to capture system requirements, perform functional decomposition, model system behavior, allocate requirements to components, and generate systems engineering documentation.
- BONEs (Block Oriented Network Simulator) from Alta Group is used to perform token-based high-level system simulation, such as modeling network traffic, and is used to obtain detailed performance metrics early in the system design.
- PRICE S/M/H/HL from Lockheed Martin PRICE Systems is used for computer-aided parametric cost estimating and enables life-cycle cost analysis throughout the design process.
- RAM/ILS from MSI enables feedback on reliability, availability, maintainability, and integrated logistics to support early tradeoff analyses.
- GEDAE™ from Lockheed Martin ATL is a graphical programming and autocoding environment.
- MATLAB from Mathworks for algorithm development and numerical analysis.
- SPW from Alta Group for algorithm development.
- The Component and Library Management System (Explore (CLMS)) from Aspect is an object-oriented extension to the existing commercially-available Component Information System (CIS) product.
- Interleaf's Technical Publishing System (TPS) is the documentation production tool, which supports all levels of the design process.

1.1.2 Hardware/Software Co-Design CAE Tools (Architecture Definition Process)

The Hardware/Software Co-Design tools support the Functional Design, Architecture Selection, and Architecture Verification efforts of the Architecture Definition process. Software design tools support library development, detailed design, and source code development. These tools are:

- JRS Research Laboratories, Inc. NetSyn enables architecture selection via a design advisor.
- SavanSys from Savantage, Inc. is a tradeoff analysis tool focused on packaging and interconnection of high-performance electronic systems.
- Lockheed Martin ATL's GEDAE™ provides a workstation environment to develop applications, tools to support multiprocessor scheduling and mapping, and a run-time environment to efficiently execute on scaleable embedded processors.
- Management Sciences' RAM/ILS enables feedback on reliability, availability, maintainability, and integrated logistics.
- Alta Group's Signal Processor Worksystem (SPW) enables interactive design, simulation, and implementation of digital signal processing and communication systems.
- BDTI/UC Berkeley's Ptolemy supports multi-domain analysis of complex systems.

- RDD-100 (Requirements Driven Development) from Ascent Logic is used to capture system requirements, perform functional decomposition, model system behavior, allocate requirements to components, and generate systems engineering documentation.
- RTM (Requirements and Traceability Management) from Marconi Systems is used as the requirements traceability tool throughout a program's engineering life cycle.
- PRICE is used for computer-aided parametric cost estimating.
- SimMatrix from Precedence provides a mixed domain co-simulation environment.
- Mentor QuickVHDL provides a VHDL compilation and simulation capability.
- MATLAB is used for algorithm development and numerical analysis.
- Harris EDAnavigator from Harris Electronic Design Automation, Inc. is an alternative tool to Savantage's SavanSys.
- Performance Modeling Workbench (PMW) from Omniview and Honeywell Technology Center allows a designer to rapidly create alternative hardware/software architectures and simulate them to validate system performance.
- ObjectGEODE from VERILOG enables the generation, verification and validation of target code for the command program.
- BEACON from Applied Dynamics International (ADI) is an alternative tool to ObjectGEODE. It can be used to generate code for the command program, test vectors for unit tests as well as product documentation.
- Lucent's SPEAR supports a customizable debugging environment for multiprocessors.
- University of Oregon's PIE is an application and design evaluation environment.
- Management Communications and Control Inc.'s (MCCI) Autocoding Toolset provides autocode generation and a run-time system for graph execution control.
- GEDAE™ from Lockheed Martin ATL is a graphical programming and autocoding environment.
- Interleaf is the documentation production tool.

1.1.3 Hardware Design Tools

The RASSP Baseline 2 system provides design capabilities for hardware design in the digital and mechanical areas. The hardware design tools shown in Figure 1.1-1 have been selected and are being integrated to provide a full complement of capabilities. Mentor provides the base system for design capture, simulation, and layout.

- Mentor's FALCON Framework is used to provide a common user interface and data interchange and management capabilities. This framework is used to integrate Mentor tools and third-party applications into a single environment. The Mentor Graphics tools Design Architect, QuickVHDL, and QuickPath provide design capture, VHDL simulation, critical path analysis, functional simulation, statistical fault grading, and fault simulation, respectively. Physical design of modules is provided by the Board Station, Hybrid Station, and AutoTherm tools from Mentor Graphics.
- SimMatrix from Precedence provides a simulation backplane to support co-simulation using different simulators.

- The System Realizer Family of Modular Emulation Systems from Quickturn Design Systems provides the capability for hardware emulations.
- VHDL is generated using the graphical tool, Visual HDL, from Summit Design.
- Synopsys tools provide an environment for compiling, simulating, and synthesizing design descriptions written in VHDL.
- Programmable Logic Device and FPGA design are supported by MGC's PLD Synthesis II and NeoCAD.
- Hardware modeling capability is provided by the LM family from the Synopsys Logic Modeling Group.
- SavanSys from Savantage, Inc. is a tradeoff analysis tool focused on packaging and interconnection of high-performance electronic systems.
- Testability analysis and test database translation is accomplished through VICTORY from Teradyne and TDS from Summit, respectively.
- Managing part libraries for electrical design is accomplished through Mentor's Library Management System (LMS) software.
- Mechanical design is supported primarily by software supplied by SDRC. Their I-DEAS Master Series software provides a complete complement of mechanical design capabilities, including thermal analysis, 2D (2-dimensional) and 3D design and modeling, and finite element analysis.
- VHDLcover from VEDA Design Automation, Inc. analyzes VHDL code and determines how thoroughly the design has been tested.
- RDD-100 (Requirements Driven Development) from Ascent Logic is used to capture system requirements, perform functional decomposition, model system behavior, allocate requirements to components, and generate systems engineering documentation.
- Interleaf is the documentation production tool.

1.1.4 Design-For-Test Tools

The RASSP DFT toolset is integrated into all five processes of the RASSP methodology: systems, architecture, detailed hardware and software design and integration/test. The DFT toolset interoperates with and in some cases uses functional design tools to support all phases of the product life cycle from design verification through manufacturing test and field support.

The Baseline 2 toolset is comprised of COTS tools which have been selected based upon function and inter-operability with the functional design tools.

System Process Tools

- TSTB WAVES Test Vector generation packages from Rome Laboratory and integrated into the Mentor QuickVHDL environment are used to develop test benches in WAVES Level II format.
- WSTA by NUWC develops functional dependency models and diagnostic strategies.
- STAT by Detex Systems, Inc. develops functional dependency models and diagnostic strategies from Mentor Design Architect netlists. A translator to the Personal Atlas Workstation Software (PAWS) by TYX Corporation facilitates the incorporation of the data into Technical Requirement Documents.

- The Test Strategy Diagram (TSD) is a graphical construct which describes how flaws and faults associated with the life cycle phases of a project are handled by a set of assigned means. It is refined throughout all phases of the design cycle.

Architecture Definition Process Tools

- TSTB WAVES packages, SW Test Works and STAT are used during the architecture definition (selection and verification) process similar to the system process as described above.
- During Architecture Selection and Verification, BIT and fault tolerant modes/functions are captured as algorithms and flowgraphs using the normal functional design tools such as SPW by Comdisco.
- During Architecture Verification BIST insertion, testability analysis and statistical fault grading tools are used as the preliminary designs are developed. TSTB WAVES is used to evaluate the capabilities of test equipment in measurement of required system parameters.
- ASICTEST by Logic Vision SW is used to perform preliminary test structure insertion (BIST and Boundary Scan) and to capture boundary scan descriptions of new ASICs for use in board level testability analysis tools such as VTM:TOP.

Detailed Design

- TSTB WAVES Test Vector generation packages from Rome Laboratory and integrated into the Mentor QuickVHDL environment are used to develop test benches in WAVES Level I format.
- STAT by Detex Systems, Inc. develops functional dependency models and diagnostic strategies from Mentor Design Architect netlists. A translator to the Personal Atlas Workstation Software (PAWS) by TYX Corporation facilitates the incorporation of the data into Technical Requirement Documents.
- ASIC Test Tool Suite by Logic Vision SW is used to perform test structure insertion (BIST and Boundary Scan), test pattern generation, fault grading and to capture boundary scan descriptions of new ASICs for use in board level testability analysis tools such as VTM:TOP.
- VTM:TOP by Mentor Graphics is used to assess the board/MCM testability based upon boundary scan and testpoint insertion.
- VICTORY by Teradyne is used to generate boundary scan test vectors for device oriented (BICT, VCT and BFT), network-oriented test (VIT and VCCT) for virtual interconnect test of components and clusters.
- LASAR will be used in conjunction with other tools to aid in developing appropriate test vectors for functional, toggle and fault tests. Its min-max simulation capability will minimize the amount of time spent debugging test programs on testers or in target systems.
- TDS by Summit is used for conversion and enhancement of simulation test vectors into tester specific formats.
- ASSET Diagnostic System is used to develop boundary scan test programs and diagnostics. During integration and test phases, ASSET is used to control, debug and isolate problems. ASSET's Scan Function Library and ScanEngine are used to generate test programs for embedded T&M controllers which control 1149.1 resources.
- Synopsys Test Compiler combines test synthesis, ATPG, fault simulation, and test management to automate DFT.

- Mentor FASTSCAN, QuickGrade, and PTM:SITE are used for scan insertion, fault grading, and test point insertion, respectively.
- SCANease is an alternative to ASSET Diagnostic System Tools.
- STARS (formerly DARTS) from MSI Systems generates a model base for a system which provides diagnostic analysis capability and repair recommendations.
- Economic Modeling Tools from Test Economic Services present a comparison of board/ASIC costs based upon entry of board/ASIC/design details with special emphasis on ATE and BScan DFT.
- IKOS Voyager is proposed to be used for fault simulation.
- The Fault Simulation Accelerator from ZYCAD may be used.

1.1.5 Enterprise System Tools

An enterprise system provides the tools and facilities for managing and providing access to the enterprise information and integrating the automated processes of an enterprise. The enterprise system for RASSP is defined as the integrated set of tools and facilities required to support the development of a signal processor prototype - design, manufacturing, test, management, procurement, etc. These tools include the following:

- DMM (Design Methodology Manager) from Intergraph is used to execute workflows (methodology) defined for a project or a high level task such as detailed design.
- DM (Document Manager) from Intergraph is used to manage product information across the enterprise.
- Explore (CLMS) from Aspect classifies, manages and cross-references all component, supplier and design data and automates the processes associated with this information, as well as the VIP Family of Component Reference Databases.
- TriTeal Enterprise Desktop (TED) from TriTeal is a graphical desktop environment that provides independence from the underlying operating system and hardware.
- MI (Manufacturing Interface) from SCRA is a standards based capability to perform design-for-manufacturing analysis and perform data translations between design and manufacturing tools.
- Communiqué and Cooltalk by Insoft support a wide variety of information exchange mechanisms to support collaborative work.
- Netscape Enterprise Server from Netscape provides secure communication and browsing capabilities over the Internet.
- PGP from Viacrypt allows users to ensure that their messages are read only by intended recipients by using public key encryption.
- WorkExpert from Mentor is used to execute workflows to automate tasks.
- ProSim from KBSI is a process modeling tool used to capture processes and tasks related information. ProSim generates models that can be simulated by simulation tools such as WITNESS.
- WITNESS from AT&T is a discrete event simulation engine that provides capabilities to perform what-if analysis and evaluate alternatives based on simulation results.

- MS Project from Microsoft is used to perform project planning, scheduling, and tracking.

1.2 Hardware for CAD Environment

The high performance SPARCsystem and Series 700 workstations developed by SUN Microsystems and Hewlett Packard, respectively, are the hardware platforms that have been selected to support the RASSP design process. These hardware platforms come in a variety of configurations to support even the most demanding engineering task. The workstation type, RAM, local disk space, and server/network performance are the main factors in determining the overall performance. Each user's workstation should have sufficient RAM to support the entire tool set. A minimum of 64 MB of RAM is required (128 MB is preferred) for an individual workstation. At least 300 MB of local hard disk should be allocated for the "swap" area required for the implementation of virtual memory. An initial estimate should be taken to determine the disk size of the server or central repository. At least 10 GB will be required and, depending on the size of the project, 50 GB or more may be required.

2. SYSTEM DESIGN TOOLS

2.1 Process Summary

The System design process encompasses the following steps:

- Extract customer requirements from source documents using either RDD-100 or RTM as the requirements tool.
- Perform requirements engineering management/clarification/traceability using the selected requirements tool. Define keywords, rules and relationships. Expand/focus requirements for testability and verification while maintaining an audit trail.
- Export data (requirements, relationships, etc.) to RDD-100 if RTM is used as the requirements tool. One-to-one mapping of elements between RDD-100 and RTM is required. This initial baseline for requirements analysis can be maintained in RTM for tracking purposes.
- Use RDD-100 in conjunction with BONEs, SPW, and MATLAB to perform System Definition, Functional Analysis, Functional Allocation, Interface Design, scenario development, thread analysis, etc. Derived requirements will be identified.
- Derived requirements along with functional allocations will be exported back to RTM to maintain traceability throughout the program lifecycle if RTM is used as the requirements tool.
- RDD-100 will export data which requires detailed simulation, performance verification, and architectural tradeoffs to BONEs. Traceability is maintained in RTM if RTM is used as the requirements tool.
- RDD-100 will generate system and subsystem specifications, SSDD, ICD's, etc. in Interleaf.

2.2 System Design CAE Tools

The RASSP Baseline 2 Systems design toolset includes:

- RTM (Requirements and Traceability Management) from Marconi Systems is used as the requirements traceability tool throughout a program's engineering life cycle.
- RDD-100 (Requirements Driven Development) from Ascent Logic is used to capture system requirements, perform functional decomposition, model system behavior, allocate requirements to components, and generate systems engineering documentation.
- BONEs (Block Oriented Network Simulator) from Alta Group is used to perform token-based high-level system simulation, such as modeling network traffic, and is used to obtain detailed performance metrics early in the system design.
- PRICE S/M/H/HL from Lockheed Martin PRICE Systems is used for computer-aided parametric cost estimating and enables life-cycle cost analysis throughout the design process.
- RAM/ILS from MSI enables feedback on reliability, availability, maintainability, and integrated logistics to support early tradeoff analyses.
- GEDAE™ from Lockheed Martin ATL is a graphical programming and autocoding environment.
- MATLAB from Mathworks for algorithm development and numerical analysis.
- SPW from Alta Group for algorithm development.

- The Component and Library Management System (Explore (CLMS)) from Aspect is an object-oriented extension to the existing commercially-available Component Information System (CIS) product that forms the basis of the design reuse library.

The RASSP Baseline 2 Systems engineering tools are depicted in Figure 2.2-1.

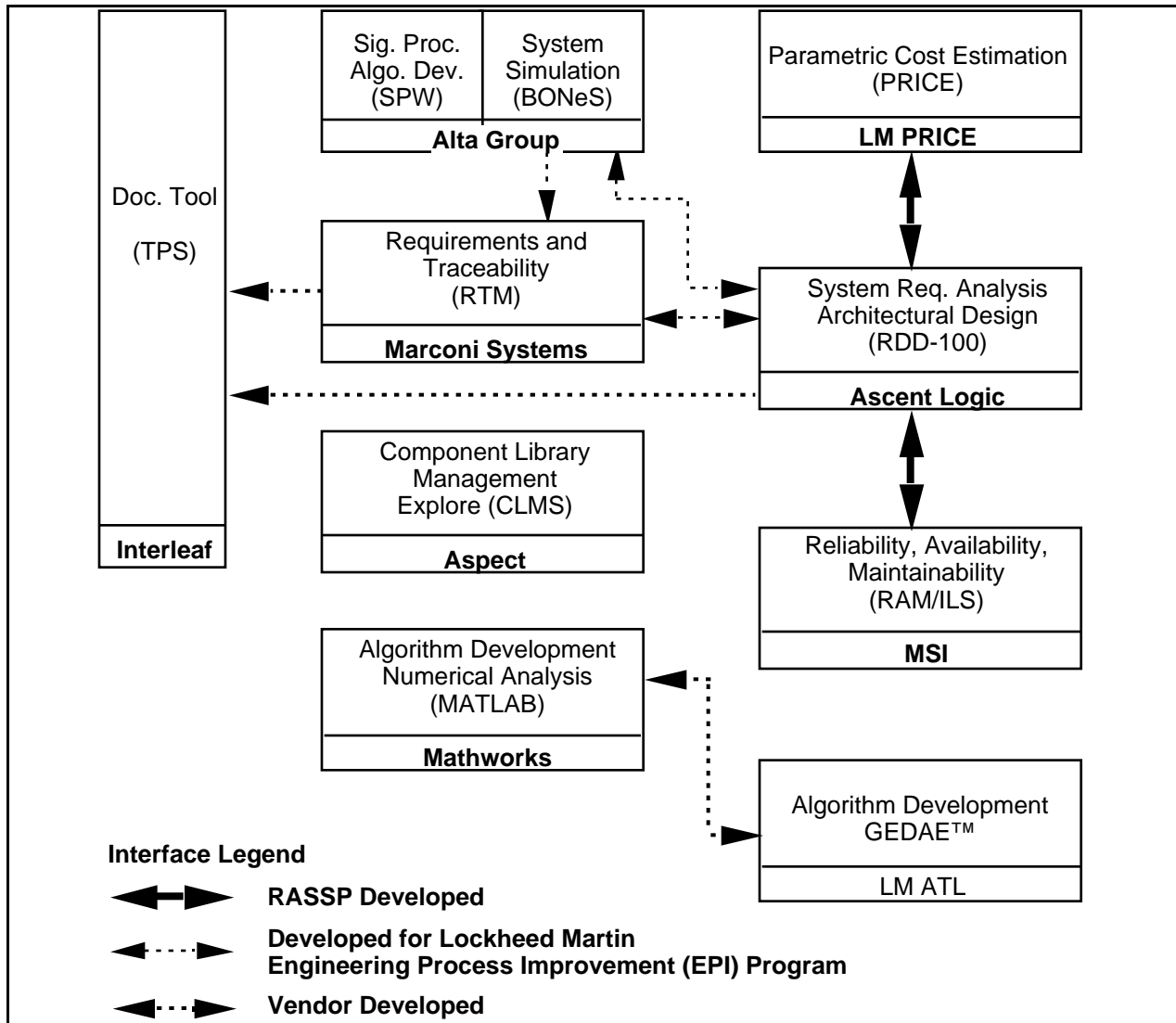

Figure 2.2-1. RASSP Baseline 2 system design tools.

2.2.1 Marconi Systems

2.2.1.1 RTM

Requirements and Traceability Management (RTM) provides the tools necessary to manipulate original customer system requirements specifications into a clear and unambiguous set of requirements to control design, implementation and testing. See Figure 2.2-2. Whenever a requirement is altered, a record is kept so that it is always possible to trace the evolution of a requirement back to its source. At this point in the requirement engineering process it is possible to rebuild the source (customer) document exchanging the original requirements with their successors. Ultimately this allows an updated requirements document to be published to the

customer in a format compatible with his original source document, thus facilitating review and authorization of requirement statements towards an approved requirement baseline.

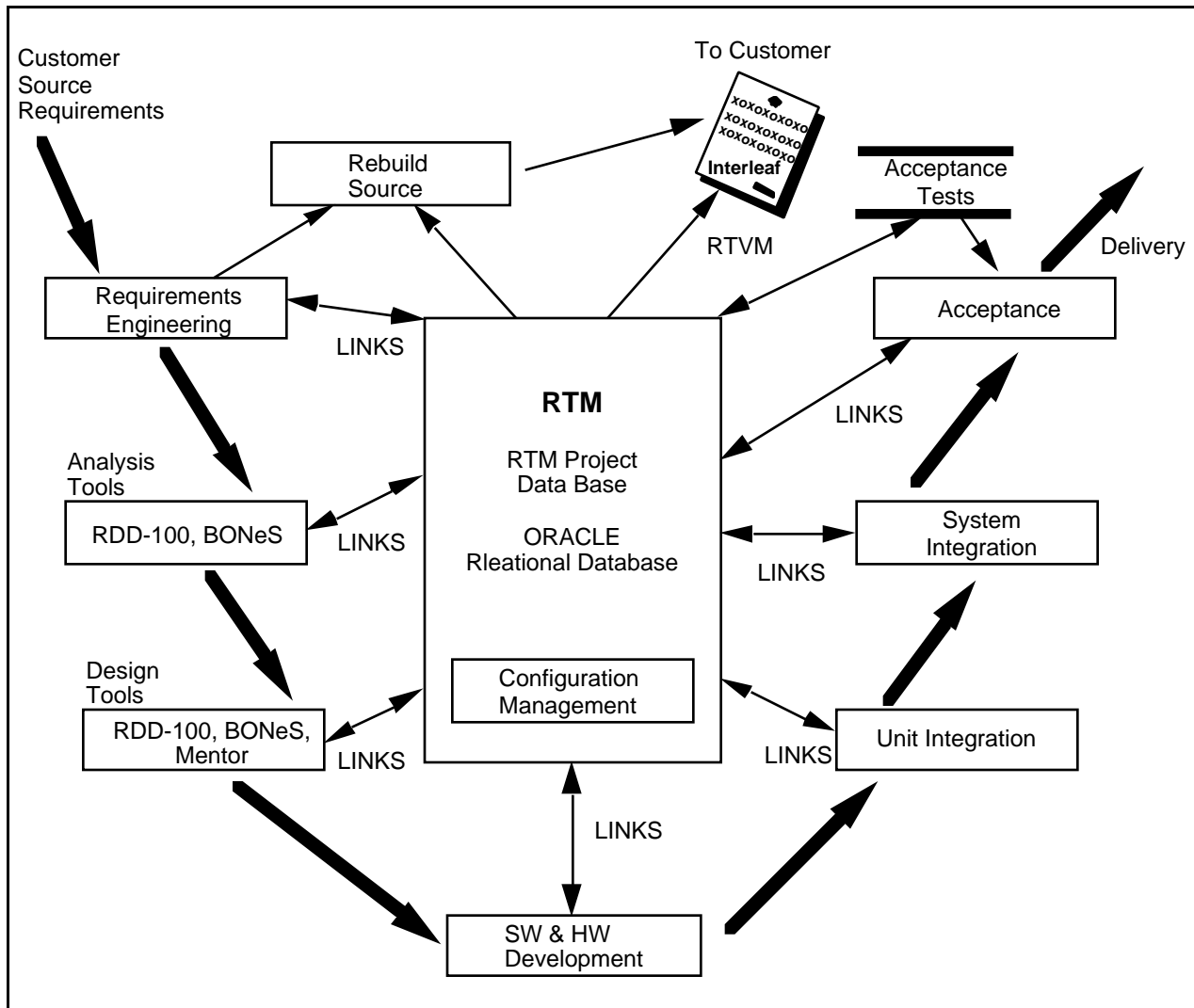

Figure 2.2-2. RTM lifecycle support.

RTM allows requirements to use indexed by keywords (e.g., performance, weight, power consumption, etc.) thereby allowing the user to obtain lists of related requirements. When requirements are extracted from a customer source document (multiple source documents are allowed), the RTM system associates various pieces of information with it. Some of this information is supplied by the system, some by the user. On extraction, the system always associates a unique number (called the key) with a requirement together with the date of extraction, the name of the source document and the name of the user performing the extraction. The system also associates a life cycle status with the requirement. This reflects how a requirement has been altered, if at all. A date and user name are stored for the most recent alteration to a requirement. As mentioned previously, links are maintained between requirements and their successors. These are all updated automatically by the system. The user is able to state attributes for the requirements. An attribute describes a characteristic of a requirement, e.g., its type, its level of acceptance, etc. Additional features of RTM are given below.

- Requirements Stripper Tool - This tool is used to extract requirements from the source document. The remnant of the source document is stored for use later when rebuilding the

document. As each requirement is extracted, the user optionally enters a paragraph identifier (paragraph ID) and attribute values as appropriate. The paragraph ID is a type of index to indicate the original position in the document of the requirement.

- Requirement Focus Tool - This tool is used to combine requirements with similar meaning, so that a single consistent version can be maintained. When there are several source documents, there may be several duplicated requirements, possibly with similar wording. The tool may also be used to alter or enter clarification and query text, e.g., to justify the focusing of these requirements together.
- Requirement Expansion Tool - The Requirement Expansion tool is the opposite of the Focus tool. It allows extracted requirements to be split into several expansion (substitute) requirements. It is used when a requirement from a source (spec., RFP, etc.) encompasses a number of individual requirements. Splitting the compound requirement allows each of the constituents to have its own set of attributes, and to be mapped to the most appropriate part of the design process. Clarification and query text may be entered and altered for the requirements.
- Requirement Editor Tool - The Requirement Editor tool provides the remaining functions essential for requirement alteration. The editor makes it possible to mark a requirement as deleted (i.e., that it is redundant, no longer required). A requirement may be changed and replaced. To correct errors, derived requirements (i.e., not directly extracted from the source document) may be deleted from the Project Database. Clarification and Query text may be entered and altered for the requirements.
- Keyword Editor Tool - This tool performs the task of "grouping" requirements. Keywords may be entered as a form of classification and requirements may be linked to them in various ways. It is possible to view a list of requirements classified by a particular keyword. Keywords can themselves be grouped into hierarchies.

2.2.2 Ascent Logic

2.2.2.1 RDD-100

RDD-100 is a front-end tool that supports the requirements and functional analysis steps of the RASSP EPI Baseline Systems Engineering process. It enables the systems engineer to take RTM-captured requirements for top-level system design, analyze and model behavior that satisfies those requirements, design components that implement that behavior, examine architecture tradeoffs, and handle exceptions. See Figure 2.2-3.

Throughout this process, RDD-100 performs hundreds of static consistency checks to verify the completeness and traceability of the system under design. The Dynamic Verification Facility (DVF) is used observe the dynamic behavior of the system for potential timing or resource utilization problems.

RDD-100 uses predefined templates to create a variety of customer documents (for example, DOD-STD-2167A System/Segment Specifications, Interface Requirements Specifications, and several versions of the Software Requirements Specification). This customer documentation is extracted directly from the data generated during the verification of the design and system model analysis. Project documentation is therefore a byproduct of the systems engineering process, and it is always congruent with the system model.

RDD-100 contains a collection of utilities for creating, accessing, manipulating, extending, viewing, analyzing, and interfacing to/from elements in the System Descriptor Database (SDD). The system design is described in an Entity/Relationship/Attribute (ERA) Model. With this notation, a user specifies instances of elements (e.g., System Requirements) and describes their specific attributes and relationships to other elements (e.g., functions that fulfill those requirements).

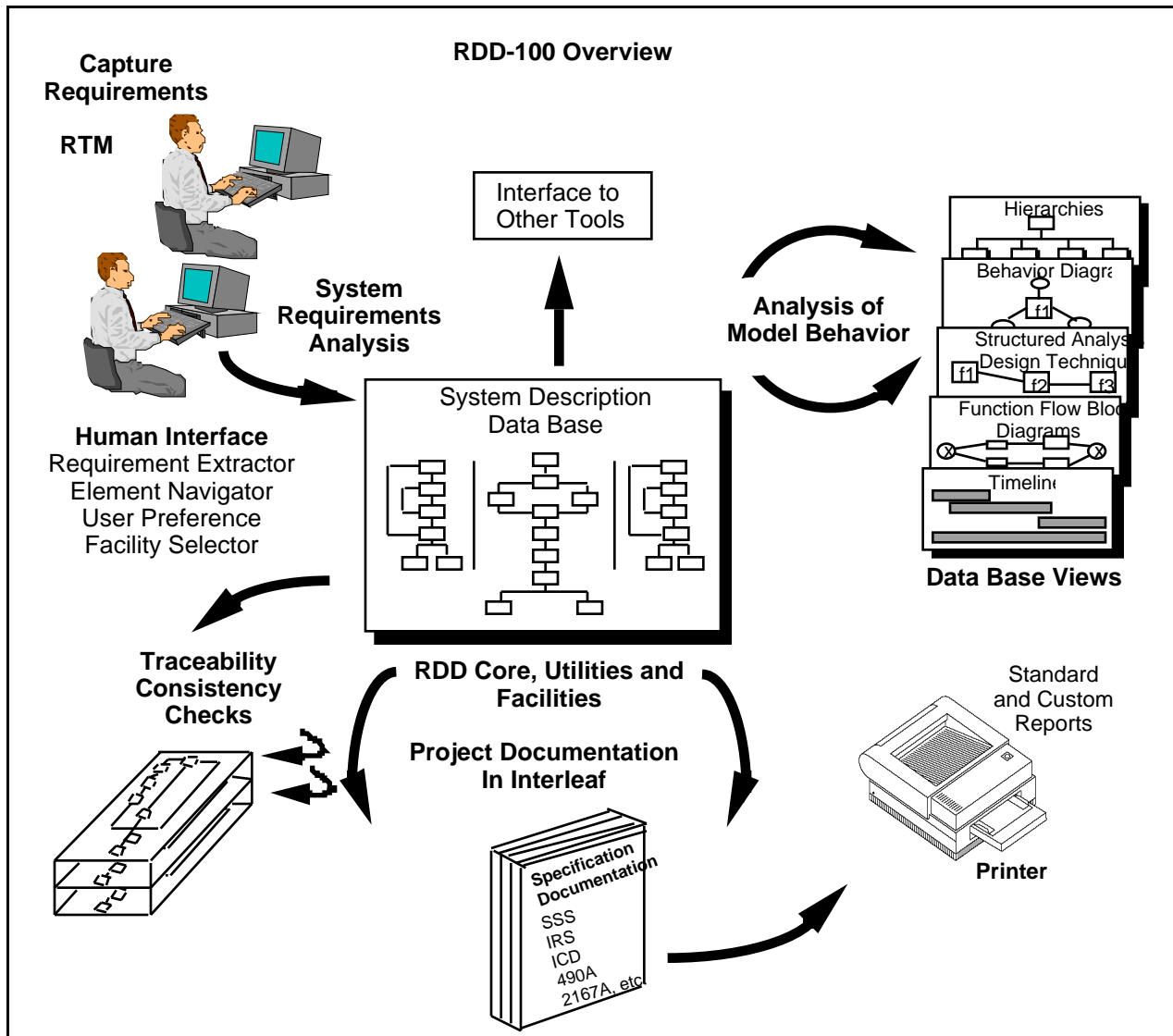

Figure 2.2-3. RDD-100 supports requirements and functional analysis.

There are four items that define an RDD-100 Facility (collection of similar elements):

- Schema - the definition of elements, attributes and relationships among the elements for a specific area (i.e., the core systems engineering schema).
- Views - the definition of the user interfaces for viewing the schema elements in a facility. RDD-100 is delivered with a standard set of views for displaying data (i.e., Behavior Diagrams).
- Consistency Checks - the definition of the consistency rules among the schema elements for maintaining design integrity (i.e., fundamental checks).
- Reports - report templates are stored and used to organize and format contractually required documents (i.e., DID compliant 2167A and 490A reports).

The information in the SDD can be viewed in either Behavior Diagram (BD) form or other kinds of function graphs which include: IDEF0 Diagrams, N-Squared Charts, Function Flow Block

Diagrams (FFBD), or Data Flow Diagrams (DFD). Behavior diagrams display the most information and you must create a Behavior Diagram before the information can be displayed in any other function graph type.

Another system view is provided by the Hierarchy Chart. These charts start with a top level element and trace through one or more relationships down a hierarchy to any number of levels.

This output can be an Interleaf "book", a postscript file, arbitrary ASCII output, Encapsulated PostScript files, or Context Document compatible. The user can generate report specifications from scratch, or modify the supplied templates.

A Behavior Diagram is a graphic view which represents both input/output data flow and a time order sequence of events. Behavior Diagrams can be decomposed hierarchically, show order of functional activation (precedence/relationship), define control data flow, and exit (completion) conditions. Related text shows performance traceability and other data (such as text descriptions). The sequence of behavior flow is generally top down and left to right. Behavior diagrams are comprised of Functions and Items. Functions and Items can be either Time or Discrete. A Function is a part of the system that carries out an action (i.e., convert an input to an output). An Item is something that a function accepts (input) or produces (output).

Behavior Diagrams have many constructs that control time flow. Refer to Figure 2.2-4. They include; Sequence, Concurrency, Select, Iterate and Replicate. A sequence is the simplest and most common structure. It consists of a single, vertical time-flow line with a series of functions in order from top to bottom.

A concurrence or parallel represents multiple paths of a process that can occur at the same time based on certain conditions, inputs, etc. Functions below the concurrence cannot start until all branches of the concurrence have completed. For example if there are two branches in a concurrence and one branch takes 5 minutes to complete and the other branch takes 5 hours and if both were started at the same time, functions after the concurrence could not be executed until the 5 hour branch is complete.

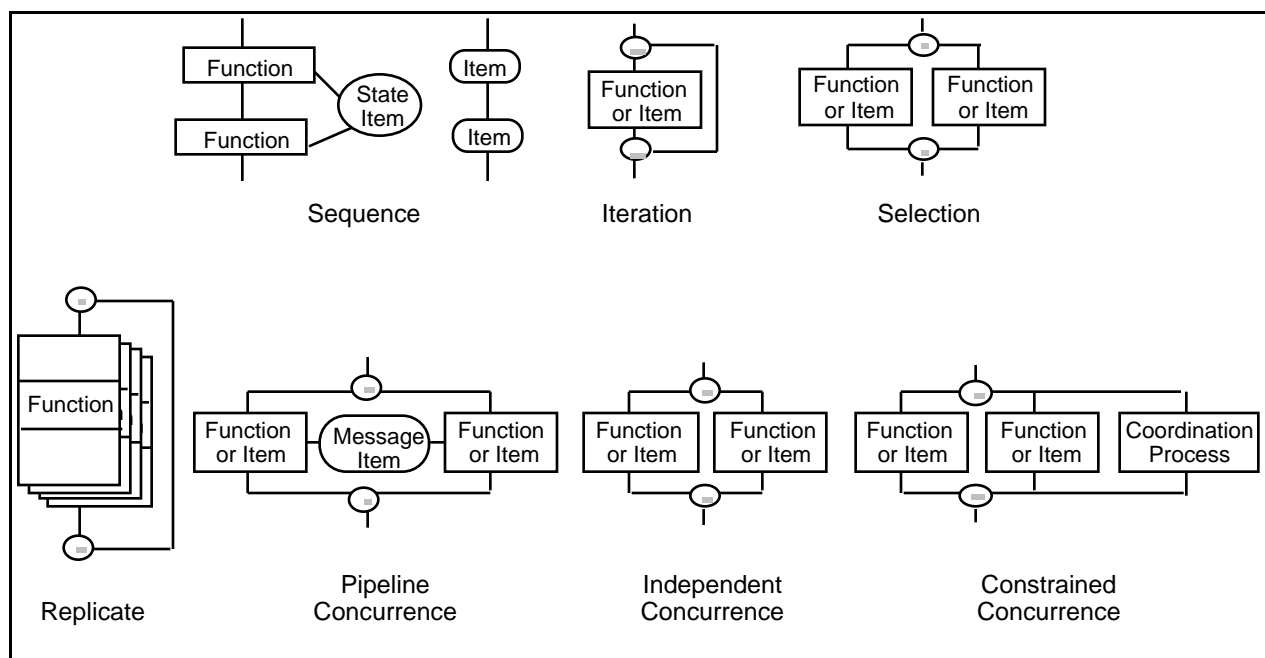

Figure 2.2-4. Behavior diagram structures.

2.2.3 Alta Group

2.2.3.1 BONeS

The Block Oriented Network Simulator (BONeS) provides a Motif graphical environment for capturing the design of communication networks and simulating the performance of the captured design. The network design is created graphically by hierarchical, data flow block diagram generation.

The Data Structure Editor (DSE) is used to create data structures which are defined hierarchically and have an arbitrary number of fields. Fields can contain simple entities such as packet lengths and time stamps, or other data structures.

The Block Diagram Editor (BDE) is used to create network models. Primitives and other blocks are placed and connected to perform functions.

When the network model is completed, error and consistency checking is done. An event driven simulation of the network is executed using the Simulation Manager with user specified values for model parameters. An interactive simulation can be run to watch the flow of data on the diagram. Simulation continues until there are no more data structures in the block diagram or until the simulation clock reaches a user specified stop time.

During simulation BONeS collects data in the network using a variety of probes at user specified locations. The data collected during simulation is analyzed and displayed graphically using the Post Processor (PP). A variety of statistical analysis routines are available.

2.2.3.2 Signal Processing Worksystem (SPW)

The Signal Processing Worksystem (SPW) provides tools needed to interactively capture, simulate, and test a wide range of digital signal processing (DSP) designs. SPW is used to evaluate various architectural approaches to a design and to develop, simulate and fine tune DSP algorithms.

The Block Diagram Editor (BDE) is used to create network models. Primitives and other blocks are placed and connected to perform functions.

The Signal Display Editor (SDE) is used to create, display, edit, process and analyze signal waveforms.

The Simulation Program Builder converts the signal flow block diagram from the BDE database into an executable program that simulates the behavior of the signal processing system. It takes the simulation inputs from the SDE database and places the simulations outputs into the SDE database

2.2.4 Mathworks

2.2.4.1 MATLAB

MATLAB is a high-performance, interactive numeric computation and visualization environment. It combines the advantages of hundreds of prepackaged advanced math and graphics functions, with the flexibility and extensibility of a high-level language to customize and add new functions as needed. MATLAB combines numeric analysis, matrix computation, sparse matrix computation, signal processing, 2-D and 3-D graphics, and other functions with a user interface where problems and solutions are expressed mathematically without the need for traditional programming.

MATLAB application toolboxes extend the functionality of MATLAB by providing algorithms and functions developed by renowned experts in digital signal processing, control system design,

neural networks, system identification, dynamic simulation, optimization, and other application areas.

The MATLAB Signal Processing Toolbox works with MATLAB numeric computation software for 1-D and 2-D digital signal processing and time-series analysis. The Toolbox includes 1-D and 2-D FFTs and inverses, FIR and IIR filter design, filter response and simulation, and power spectrum estimation.

2.2.5 MSI

2.2.5.1 RAM/ILS

MSI is incorporating the RAM-ILS toolset for design assurance management into the overall RASSP system design environment. These tools measure an important quality-related aspect of the design in progress. The MSI RAM-ILS toolset consists of synergistic tools working within the design framework. The RAM-ILS toolset uses the design toolset to assess functional robustness, functional reliability, functional diagnosability, manufacturing process reliability (six-sigma quality methods), and deployment reliability-related issues. The RAM-ILS tools consist of the features shown in Table 2.2-1.

Table 2.2-1. RAM/ILS tool features.

Design Assurance Tools	Value Added
Functional Reliability Risk Allocation	Reliability goals for hardware and software
Circuit-Based Design Reliability Simulation	Calculate stress derating for component selection
Functional Reliability and Longevity Analysis	Improved performance in the operating life cycle
Deployment Life Cycle Cost Tradeoffs	Economic and Warranty Analysis
Failure Modes and Effects Criticality Analysis	Safety and Degraded Performance Analysis
Diagnosability and Repairability	Maintenance Requirements Analysis
Mission and Deployment Reliability	Durability, Capability and Performance Analysis
Maintainability and Supportability	Support Staff/Equipment Requirements Analysis
Worst Case Analysis (Aging and Degradation)	Parametric degradation analysis
Thermal Damage Analysis (Aging and Degradation)	Thermal derating analysis

Revisions to correct reliability and quality issues are a costly and time-consuming process. The MSI Design Assurance toolset will identify issues as the design progresses. The RASSP RAM-ILS tools will provide auditable 'second opinions' for the reliability, safety, producibility, life-cycle costs, and related quality viewpoints.

The RASSP Design Assurance Manager toolset provides feedback to designers from concept through completion. The MSI RAM allocation tool uses the mission requirements in a deployment simulator to allocate functional safety, reliability, diagnosability, maintainability, supportability, life-cycle costs, and quality requirements. The allocations are used as the benchmark for comparisons all phases of the design. The allocations will be used in trade-off studies to determine return on investment in terms of economic and performance issues. The MSI Primary Predicted Costs of Ownership model provides a consistent basis for trade-off studies.

The classic methods of reliability prediction Mil-HDBK-217 are based in device statistics. Much of the RASSP design process will use new, advanced technology with little statistical history. MSI's RAM-ILS toolset is based on reliability physics. Parametric variation caused by heat, oxidation, humidity, and other factors of aging are integral to the RASSP RAM-ILS methods. Worst case analysis methods evaluate the robustness of a design to withstand the effects of

radiation, aging, electrical, mechanical, and thermal conditions. Digital and analog design tools are integral to the RAM-ILS evaluation.

2.2.6 Lockheed Martin ATL

2.2.6.1 GEDAE™

GEDAE™ is a highly interactive graphical programming and autocoding environment which facilitates application development, debugging, and optimization on workstations or embedded systems. Its graphical editor supports building data flow graphs which are very readable. Explicit inputs and outputs are identified and user notes can be inserted directly on the graph canvas. The same user interface which supports the graphical editor is used for controlling all activity within GEDAE™. Capability is provided for the designer to readily partition graphs and map the partitions to multiple workstations or multiple processors in an embedded system. Autocoding generates appropriate schedules and code for each processing element which is efficient in terms of execution time and memory usage.

A GEDAE™ Run-Time Kernel provides all of the interprocessor communication required by the particular software mapping. Although the designer has flexibility in selecting the type of communication used (e.g., socket, DMA, or shared memory), implementation of the communication is automatic. Therefore, the application developer never needs to write any interprocessor communication software.

Algorithms are captured in GEDAE™ by placing processing functions extracted from a library on a canvas and interconnecting them using the extensive facilities of the graphical editor. Using a top down design approach, the basic building blocks and data passing requirements can be put on the canvas. In this way, the application designer can build, test, and analyze algorithms with point and click simplicity. Designers can select from functions contained in the extensible library. Library functions are provided for most of the commonly used signal processing functions. Understanding that a function library will never be complete, templates are provided for creating new functions. In addition to providing all of the typical data types, GEDAE™ has the important capability to define new arbitrary data types (e.g., complex C structures) for use with custom primitives. This ability is of great importance to users who want to capture heritage software which is generated in modules whose I/O is maintained as complex data structures.

Hierarchy is supported in a flow graph which simplifies complex application understanding. GEDAE™ supports extensive and efficient parallel processing.

Execution of GEDAE™ graphs is controlled through the same interface used to construct the graph. Users can modify parameters in the graph on the fly and observe the impact of those changes. The ease of making modifications to a graph and its operating parameters increases productivity by making it easy for designers to fine tune applications quickly. Execution results are presented to the designer in the form of detailed timelines and execution schedules along with memory maps to support the designers analysis of system solutions.

GEDAE™ provides an efficient autocoding capability driven by partitioning and mapping defined by the user. Because GEDAE™ handles all interprocessor communication, the designer never has to write any communication software. GEDAE™ launches the compilation, linking, loading, and execution of the application on the embedded hardware. An embedded run-time kernel on each processor supports execution. GEDAE™ generates the execution schedule for each processor and provides the user the ability to divide schedules into subschedules which may all operate at different firing granularity to optimize performance. Execution schedules and memory maps are presented for analysis.

A new architecture is defined as a specific vendor's COTS product in conjunction with the operating system (or board support software) and optimized function library used by the vendor. There are three steps required to port GEDAE™ to new architectures. First, the communication software is modified to use the specific operating system and/or board support package provided

by the vendor. Second, all communication mechanisms that are supported by the specific hardware must also be supported by the autocoding for that hardware. For example, some SHARC hardware utilizes only SHARC links for all communication while other hardware also provides switching networks or local buses. In addition, various communication protocols are used including, shared memory, message passing, and DMA. Third, a version of the GEDAE™ primitive library which utilizes the optimized math library supplied by the vendor must be provided.

GEDAE™ is relatively easy to port to new architectures (even those not using an operating system) because the communication layer has been optimized and reduced to approximately 600 lines of code. ATL has ported GEDAE™ to various hardware including three different vendor's hardware architectures with different communication mechanisms, both on a board and between boards. The currently supported architectures utilize SHARC, Power PC, and i860 processors.

GEDAE™ supports the optimization of partitioning and mapping, memory usage, communication mechanism selection, schedule firing granularity, queue capacities, and scheduling parameters. GEDAE™ provides the ability to interactively manipulate these items which greatly improves the designers ability to optimize processing after retargeting an application to a new architecture.

Under the RASSP program, the synthetic aperture radar (SAR) application was implemented using the GEDAE™ tool. The application software that was hand-generated for a Mercury RaceWay architecture was re-implemented using the GEDAE™ tool on a similar Mercury architecture. The resulting autocoded application achieved the same execution and memory efficiency as the hand coded version—with approximately a 10X reduction in implementation time. The same application has been remapped to three other architectures by simply repartitioning, remapping, and reoptimizing the application on the new architecture using the optimization support within the GEDAE™ tool. The time utilized for retargeting was 2-3 days for each subsequent architecture.

2.2.6.2 PRICE S/M/H/HL

The PRICE suite of Computer-Aided Parametric Estimating (CAPE) tools are used to estimate the development, production, maintenance cost, and schedules of Hardware, Software, and Micro-circuits. Parametric cost modeling is based on cost estimating relationships (CERs) that make use of product characteristics (such as hardware weight and software language) to estimate costs and schedules. The family of PRICE parametric tools include four models which are described below. Hardware cost model (PRICE H) - The hardware cost model is used to estimate the cost and schedule for electronic, electro-mechanical, and structural assemblies. This model incorporates input data concerning yield, performance, quantity, process and design sensitivity, and complexity parameters. The hardware model provides cost and schedule output for the development and production phases of a program.

Hardware life-cycle cost model (PRICE HL) - The hardware life-cycle cost model is used to estimate the cost of operating and maintaining hardware systems throughout their deployment. Inputs to the life-cycle model include deployment parameters, maintenance concepts, cost, and escalation factors. The life-cycle model is a supplement to and operates in conjunction with the hardware model.

Microcircuit/module cost model (PRICE M) - The microcircuit cost model is used to estimate the cost and schedule for custom microcircuit, printed circuit boards, and electronic modules. The model uses functional relationships based upon parameters such as the number of transistors, percentage of new circuit cells, number of pins, board type and size.

Software/software life-cycle cost model (PRICE S) - The software cost model is used to estimate the cost and schedule for the design, development, integration, testing, and support of software. This model uses functional relationships based upon parameters such as function, lines of code, complexity, platform, application, and design reuse to estimate costs.

The PRICE cost models will be integrated with the RASSP system engineering, life-cycle support, and architecture selection tools. These integrations will allow engineers the capability to perform cost/performance trade-offs throughout the design process.

2.2.7 Aspect Development

2.2.7.1 Explore (CLMS)

The Component and Library Management System (Explore (CLMS)) is an object-oriented extension to the existing commercially-available Component Information System (CIS) product. This extension supports the implementation of the RASSP Reuse Data Manager (RRDM) subsystem and consists of the following:

- Data manager extensions
- Object viewer development
- Object editor development
- Meta-model editor development

The data manager is an existing capability which will be extended to manage default objects, template objects, and temporary objects. A default object is a model for the design objects in a given class. The attributes (properties and values) for a default object may be used as a basis for creating a new object. Template objects enforce rules about required fields and values. Template objects may be mapped to individual design objects. Temporary objects are added to the database, but marked to be deleted or moved at a later time. Temporary design objects are useful for creating test cases for converting existing data.

The object viewer will allow users to search for reusable design objects using a powerful parametric search. It will use two windows; one for entering parametric search data and another for displaying results. The results of performing a search will be a list of all reusable design objects that match the specified parameters. The user can then pick individual reusable design objects on the list and view all of the parameters and cross-references associated with each reusable design object.

The object editor will allow users to enter design objects into the RRDM, or to update existing design objects. Updates typically involve adding, deleting, or editing object parameters and test items associated with a given object, changing permissions for a given object, and copying an object to a different class. The object editor will also allow users to add mappings between objects.

The meta-model editor will allow the database administrator or librarian to modify the hierarchical class structure by adding and deleting classes. The meta-model editor will be available either in interactive or batch modes.

2.2.8 Interleaf

2.2.8.1 Technical Publishing Software (TPS)

Interleaf TPS is the common tool for document production used to create and manage technical documentation, work instructions, specifications, proposals, reports, data sheets, catalogs, forms, and correspondence.

TPS offers complete word processing, advanced graphics, automatic layout, conditional document assembly, multi-page tables to support traceability data and technical equations, data-driven charts, image editing, interactive equations, and centralized control over document content and format.

Additional Interleaf features are:

- Full WYSIWYG word processing, including spell checking, text undo, automatic numbering and wildcard search and replace.
- Automatic layout including document zooming with full editing capabilities, turn pages, facing pages, kerning, and leading.
- Multi-page, multi-column tables that can include graphics.
- A palette-based equations editor.
- Sophisticated graphics, including creation, editing, and importing of line art, graphics, and charts.
- Rotated text and graphics - at any angle.
- An extensive clip art library.
- Online context-sensitive help.
- Book management facility for multi-sectioned document assembly.
- Book catalogs for central control of format and content.
- Revision management to track changes and maintain version history.
- Linked online documents for workgroup access to most recent document versions.
- Extensive filter support including ASCII, CGM, FrameMaker, IGES, HP-GL, PICT, TIFF, Microsoft Word RTF, etc.

2.3 System Design Tool Integration

2.3.1 RDD-100/PRICE/RAM-ILS Integration (RASSP Developed)

To support the RASSP System Definition Process, Ascent Logic's RDD-100, Lockheed Martin's PRICE cost estimating tools and Management Sciences' RAM-ILS toolset have been integrated together to provide a concurrent engineering design environment over multiple domains. This interface is shown in Figure 2.3-1. RDD-100 is used to capture and analyze the requirements, to define the functional behavior of the signal processor, to allocate the requirements and functions to each signal processing subsystem and to provide requirements traceability. PRICE cost estimating tools are used to estimate the development, production and support costs for the signal processor. The RAM-ILS tool is used to perform reliability and maintainability analyses.

The types of data which are passed from one tool to another consist of the data that typically resides in that tool which can be used by the other tool. For example, system engineering data is passed from RDD-100 to the PRICE cost estimating tool. A GUI interface for the PRICE tool in RDD-100 was not developed. The types of parameters which are passed from RDD-100 to PRICE include the equipment configuration, size, weight, power, technology and complexity factors. The development, production and support costs are passed back to RDD-100 from the PRICE tool. On the other side of the interface, the equipment configuration and allocated reliability and maintainability budgets are passed from RDD-100 to the RAM-ILS toolset. The reliability and maintainability assessments are passed back to RDD-100 from the RAM-ILS tool. In addition, optimizations can be performed within the RAM-ILS toolset when the budget is not met and the tool can make recommendation on how redundancy can be added in the system in the most cost effective way to meet the requirements.

In addition, the RAM-ILS toolset is tightly integrated within Mentor Graphic's FALCON Framework. With this integration the RAM-ILS tools have access to detail design information such as thermal and stress profiles as the design progresses. This detailed design information can be used in more accurate reliability and maintainability analyses.

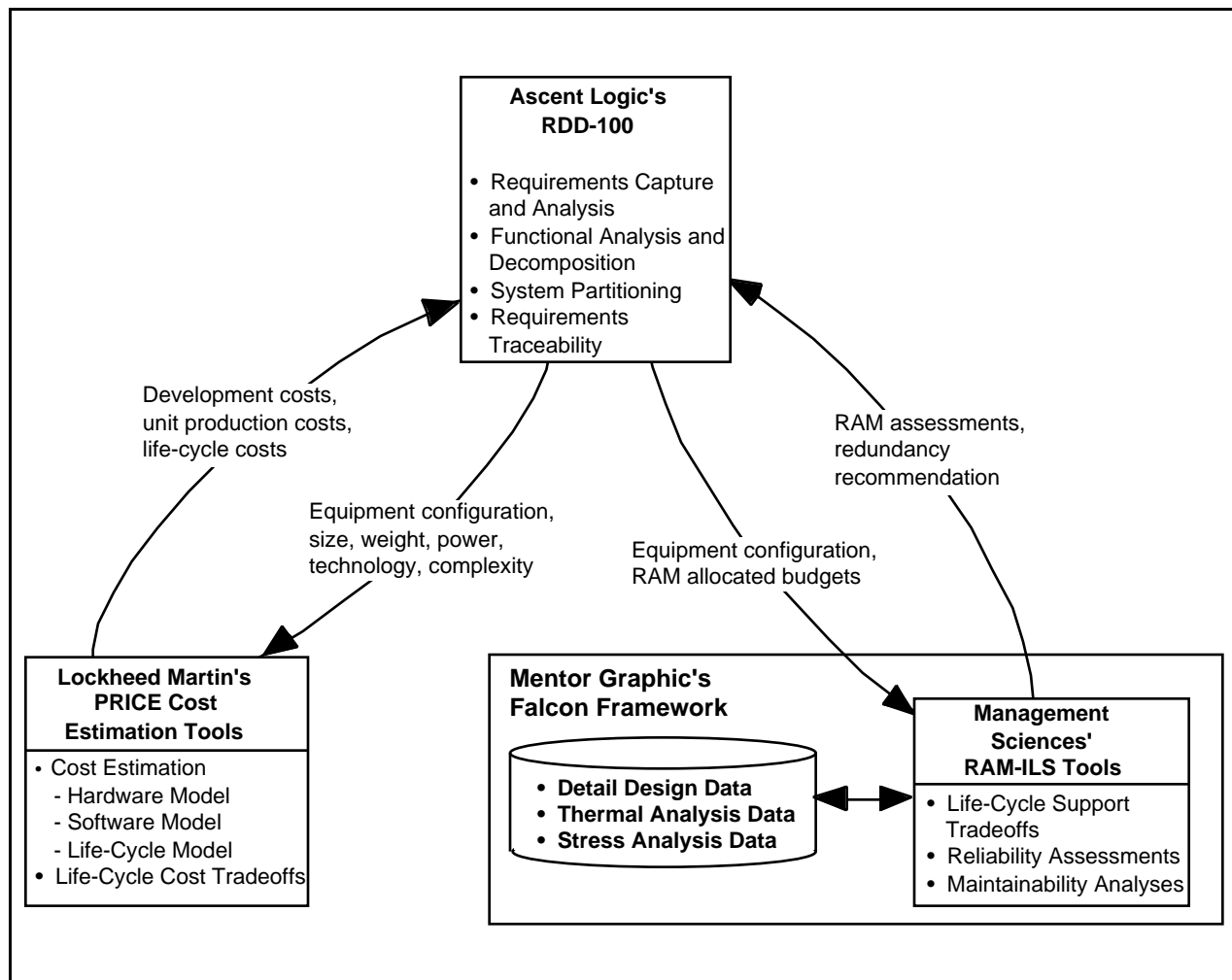

Figure 2.3-1. RDD-100/PRICE/RAM-ILS integration.

2.3.2 RTM/RDD-100 (Developed on LM EPI Program)

RTM/RDM integration supports the following process steps. An overview of the RTM/RDD-100 tool integration is diagrammed in Figure 2.3-2.

- Prepare the RTM database and populate it with customer requirements.
- Use RTM to clarify and organize requirements.
- Export requirements to RDD-100.
- Perform system definition and requirement/functional/mission analysis with RDD-100.
- Export derived requirements, critical issues, and allocations back to RTM to maintain traceability and to support impact assessment.

- Export from RDD-100 critical issues along with relevant data (requirements, functions, components, etc.) to BONEs.
- In BONEs, define models which map to imported RDD-100 elements. Capture assumptions, rationale, and derived requirements in BONEs.
- Pass back results (Pass/Fail), assumptions, rationale, derived requirements, plots, recommendations, etc. to RDD-100.

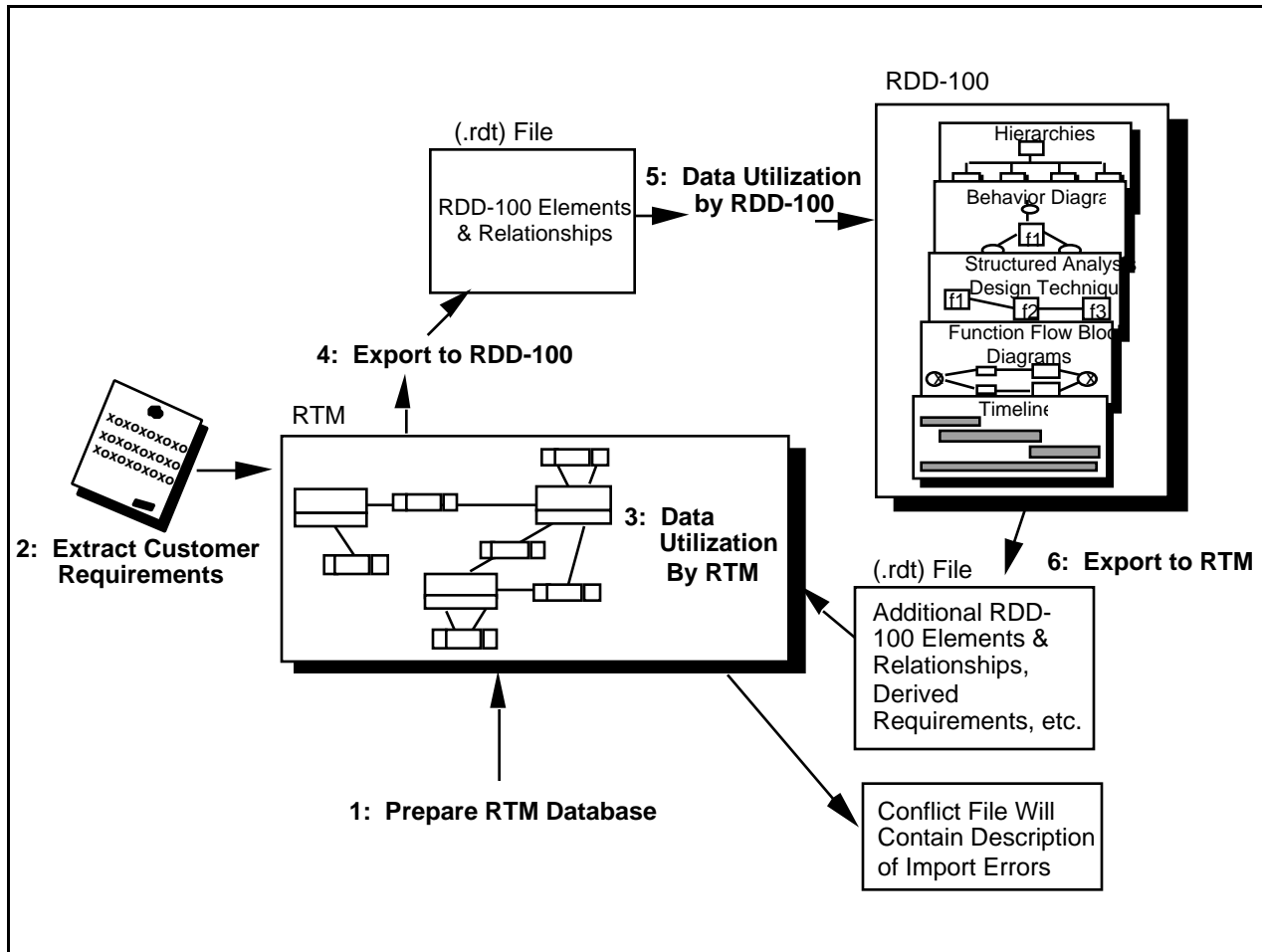

Figure 2.3-2. Overview of RTM/RDD-100 integration.

2.3.3 RDD-100/BONEs (Developed on LM EPI Program)

RDD-100/BONEs integration supports the following process steps:

- Perform preliminary system definition in RDD-100.
- System engineer evaluates results and makes final determination (accept, rerun, reallocate etc.).

Figure 2.3-3 depicts the integration of RDD-100 and BONEs.

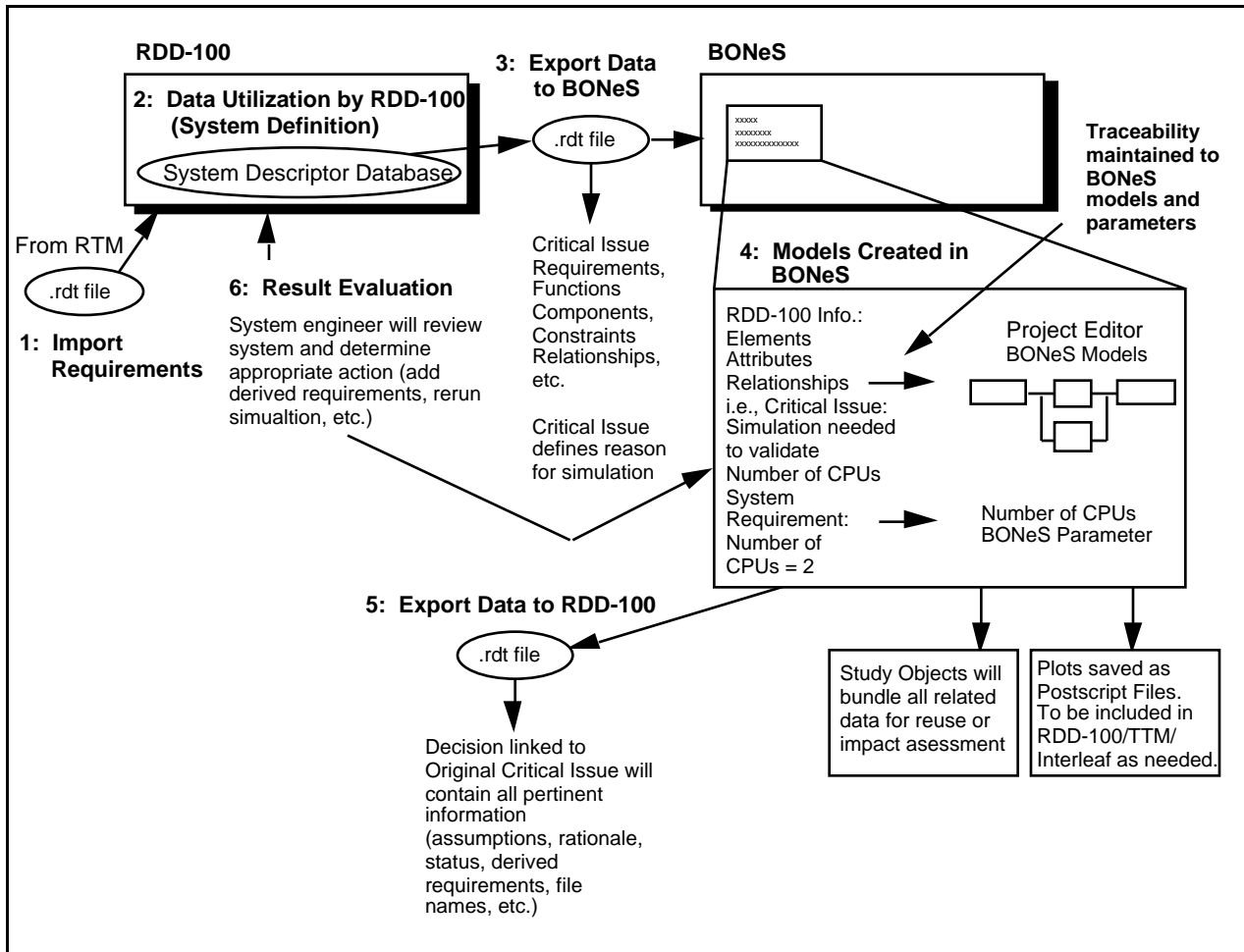

Figure 2.3-3. Overview of RDD-100 BONEs integration.

3. HARDWARE/SOFTWARE CO-DESIGN TOOLS

3.1 Process Summary

Much of the work normally associated with applications, control, and communications software development is performed in the Architecture process in the RASSP methodology. The software side of hardware/software co-design is concerned with aggregating and/or translating the compiled HOL code verified at the architectural level to downloadable target code.

Downloadable code is generated by taking autocoded and hand-generated portions of application and control code, and combining them with the communications and support software into a single executable for each processor. The run-time system, which provides the reusable control and graph management code, will have all the hooks required to interface with the support code. Figure 3.1-1 shows the software architecture.

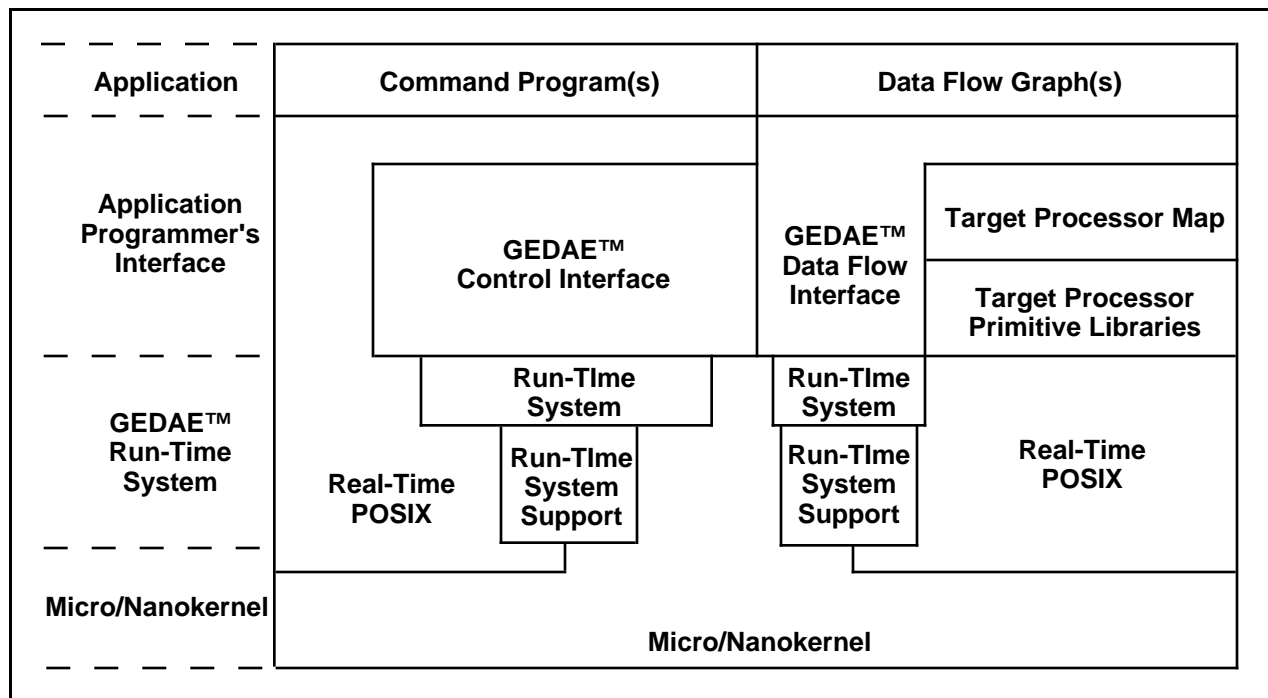

Figure 3.1-1. Software architecture.

The signal processing software development is data flow graph (DFG) driven.

The Architecture definition process transforms requirements into candidate architectures of software and hardware elements through hardware/software co-design and co-verification at all steps. It is composed of three major steps: Functional Design, Architecture Selection and Architecture Verification. The Functional Design step provides a more detailed analysis of the processing requirements resulting in initial sizing estimates, detailed data and control flow graphs for all required processing modes to drive the hardware/software co-design, and the criteria for architecture selection. During Architecture Selection, a trade-off analysis based on the established selection criteria results in the specification of the detailed architecture, software partitioning and mapping. Figure 3.1-2 depicts the major Hardware/Software Co-design tools. The virtual prototype, VP1, produced during Architecture Selection is not a full system prototype, since function and performance are simulated independently and may or may not be coupled with the overall control mechanism. During Architecture Verification, virtual prototype VP2 is produced representing a functional and performance description of the overall design. This prototype may have models at varying levels of abstraction, requiring multi-domain simulation capabilities.

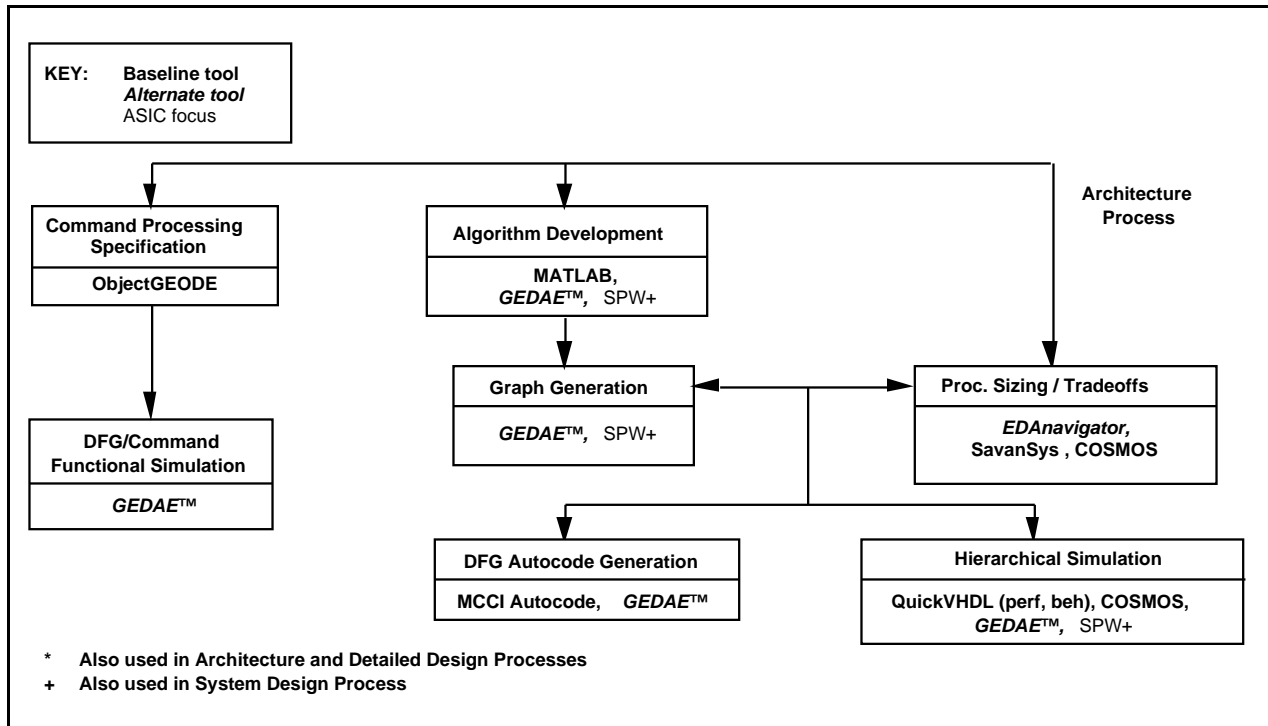

Figure 3.1-2. Architecture selection toolset.

The architecture model, taken as a whole, consists of the structure interconnection of the components, their abstract VHDL models, and the associated software descriptions. The VHDL models of programmable units are designed to interpret the data files produced by the software design process to facilitate hardware/software co-simulation and co-design. The architecture model forms the executable specification of the architecture design, and the VHDL component models form the executable specifications of the hardware components that are passed on to the hardware design process. Associated with each VHDL component model is a VHDL test bench. We design the VHDL test bench for each hardware component before the component model is designed. Since the architecture model is more detailed than the system-level performance model, the more precise results of its execution are back annotated to the system model. Likewise, as we obtain the results from the more detailed hardware models in the hardware design process, they are back-annotated to the architecture and system models.

The results of the System Design process are architecture-independent processor requirements. The Architecture Design process proceeds as follows:

- Size, simulate and optimize the algorithm implementation.
- Develop detailed Data Flow Graphs (DFGs).
- Select candidate architectures by allocating system level hardware requirements to hardware and/or software functions.
- Perform a preliminary physical partitioning.

For each candidate architecture develop:

- Functional models and non-DFG software.
- Executable software via autocode generation tools.
- Performance simulations.

- Performance analysis results.
- Reliability and cost assessment results.
- Verification plan.
- Preliminary partitioning across boards, technology trade-offs, packaging (FPGA/MCM/Discrete) trade-offs.
- Implement the appropriate DFT design steps.

3.2 Hardware/Software Co-Design CAE Tools

The RASSP Architecture design toolset for Hardware/Software Co-Design includes:

- JRS Research Laboratories, Inc. NetSyn enables architecture selection via a design advisor.
- SavanSys from Savantage, Inc. is a tradeoff analysis tool focused on packaging and interconnection of high-performance electronic systems.
- Lockheed Martin ATL's GEDAE™ provides a workstation environment to develop applications, tools to support multiprocessor scheduling and mapping, and a run-time environment to efficiently execute on scaleable embedded processors.
- RAM/ILS enables feedback on reliability, availability, maintainability, and integrated logistics.
- RDD-100 (Requirements Driven Development) from Ascent Logic is used to capture system requirements, perform functional decomposition, model system behavior, allocate requirements to components, and generate systems engineering documentation.
- RTM (Requirements and Traceability Management) from Marconi Systems is used as the requirements traceability tool throughout a program's engineering life cycle.
- Alta Group's Signal Processor Worksystem (SPW) enables interactive design, simulation, and implementation of digital signal processing and communication systems.
- BDTI/UC Berkeley's Ptolemy supports multi-domain analysis of complex systems.
- PRICE is used for computer-aided parametric cost estimating.
- SimMatrix from Precedence provides a mixed domain co-simulation environment.
- Mentor QuickVHDL provides a VHDL compilation and simulation capability.
- MATLAB is used for algorithm development and numerical analysis.
- Harris EDAnavigator from Harris Electronic Design Automation, Inc. is an alternative tool to Savantage's SavanSys.
- COSMOS from Omniview and Honeywell Technology Center allows a designer to rapidly create alternative hardware/software architectures and simulate them to validate system performance.
- ObjectGEODE from VERILOG enables the generation, verification and validation of target code for the command program.
- Lucent's SPEAR supports a customizable debugging environment for multiprocessors.

- University of Oregon's PIE is an application and design evaluation environment.
- GEDAE™ from Lockheed Martin ATL is a graphical programming and autocoding environment.
- Interleaf is the documentation production tool described in Section 2.2.8.

3.2.1 JRS Research Laboratories

3.2.1.1 NetSyn

NetSyn is used to perform application specific network definition and synthesis and analysis. The primary objective is to provide a smart designer with the tools that will enable him to mostly automatically synthesize and analyze a network. The system provides facilities for synthesizing and evaluating numerous alternatives. It enables the automated synthesis of network solutions based totally on the requirements and constraints imposed by the designer. By deriving solutions from requirements and constraints, the system ensures that solutions meet specifications and enables the quantification of the impact of specification changes.

The NetSyn synthesizes a heterogeneous multiprocessor network consisting of processors, memories, input/output, and communication entities to execute an application represented in graph form. NetSyn co-designs the hardware and software at a very early stage of the design. It automatically generates proof-of-concept and pre-production prototype designs and automatically assigns the software elements to processors in the network. NetSyn enables the user to rapidly evaluate alternative network designs by trading off hardware against software to synthesize the most efficient network architecture that meets the requirements.

3.2.2 Savantage, Inc.

3.2.2.1 SavanSys

SavanSys is a tradeoff analysis tool focused on packaging and interconnection of high-performance electronic systems. Given physical descriptions of the components to be interconnected and packaging technology selections, it will produce performance metrics including system size, routing, thermal, electrical, reliability and cost analysis for multichip and multiple board systems. Technologies treated by SavanSys include: traditional and fine-line printed circuit boards, low temperature co-fired ceramic and thin-film. Component assembly approaches include wirebonding, TAB, flip chip and single chip packages. Materials are also available for bare die attach, encapsulation, heat exchanger attach, and for defining the bonding and interconnect technologies.

The tool begins by capturing design and performance budgets and constraints. Next, the components (active and passive) to be packaged are described. Component descriptions include the entry of physical (dimensions), material, I/O (number of signal, power, ground, unused), electrical (bias level, logic swing), thermal and manufacturing (cost, tested yield, etc.). All of this information is included in the "chip" class. In addition to these properties, the characteristics of heat spreader and thermal vias are captured as properties of each component rather than the module or board so that they can be easily manipulated on a per component basis.

After the components are described to the tool, they are placed into "partitions." Partitions consist of any subset of the defined components grouped into a few chip package, MCM or printed circuit board. It is through the creation of partitions that complex systems can be built using the tool.

Designers use the Partition Manager to create new parts or import existing parts from external component libraries, distribute components and modules throughout the hierarchy, define substrate and interconnect technologies, and run concurrent analysis on various levels of the hierarchy. SavanSys allows engineers to change design concepts between different

components and connectors, packaged or unpackaged ICs, or interconnect and assembly technologies.

The Placement Editor enables engineers to quickly explore the impact of component placement (single or double-sided) on cost, weight, size, thermal, and critical net electrical performances. SavanSys can import and export system packaging specifications, including placements, and component and technology descriptions in formats compatible with PCB and multichip module (MCM) layout tools from Mentor Graphics.

3.2.3 BDTI/UC Berkeley

3.2.3.1 Ptolemy

Ptolemy is an environment for simulation and prototyping of heterogeneous systems. It uses modern object-oriented software technology to model each subsystem in a natural and efficient manner, and to integrate these subsystems into a whole. The objectives of Ptolemy encompass practically all aspects of designing signal processing and communications systems ranging from algorithms and communication strategies, through simulation, hardware and software design, parallel computing, and generating real-time prototypes. To accommodate this breadth, Ptolemy must support a plethora of widely differing design styles. The core of Ptolemy is a set of object-oriented class definitions that makes few assumptions about the system to be modeled; rather, standard interfaces are provided for generic objects and more specialized, application-specific objects are derived from these.

A basic abstraction in Ptolemy is the Domain, which realizes a computational model appropriate for a particular type of subsystem. Current examples of domains include synchronous and dynamic dataflow, discrete-event, and domains appropriate for control software and embedded microcontrollers. Domains can be mixed as appropriate to realize an overall system simulation. Some current applications of Ptolemy include networking and transport, call-processing and signaling software, embedded microcontrollers, and signal processing, including implementation in real-time on programmable DSPs, scheduling of parallel DSPs, board-level hardware timing simulation, and combinations of these.

3.2.4 Lockheed Martin ATL

3.2.4.1 GEDAE™

The Graphical Entry Distributed Application Environment (GEDAE™) is a graphical programming tool that facilitates the development of parallel distributed data flow applications on a heterogeneous network of processors. GEDAE™ provides a simple Motif interface, allowing the user to create, edit, control and monitor hierarchical data flow graphs. GEDAE™'s simple programmer interface makes it possible to easily create primitive function boxes by encapsulating existing software in a C language shell. GEDAE™ maintains much of the efficiency of special purpose code while hiding the details of network interconnection and data flow. GEDAE™'s data flow control software takes advantage of any data parallelism or pipelining inherent in the constructed data flow graph. Data flow is efficient because objects cast or transfer themselves differently, depending on the type of data transfer, to optimize communications efficiency. An autocode generation capability provides the ability to automatically generate source code for multiprocessors and to efficiently support fine-grained data flow graphs. Currently, GEDAE™ is being enhanced to allow applications developed in a workstation environment to be mapped to embedded processors for efficient execution.

The GEDAE™ software structure, as discussed above, allows an application programmer to develop modules independently of how they are connected. It allows a user to connect modules independently of how they are implemented and where they are executed. Data transfers across the network, data casting (translation) between different data types, and data transfers between host and remote processors are all transparent to the user. Function-box application programmers can develop a module without knowing how it will be used in the system because

they do not need to specify how data is transferred. This knowledge is embedded in the input and output data objects themselves. Many standard data types are provided by GEDAE™ and tools for creating new data types are available. The object-oriented nature of the environment cleanly separates function box design, data type design, and user interface design.

GEDAE™ runs on Sun Solaris, HP, NT, and SGI workstations. GEDAE™ is built using readily available network and graphic standards. The only requirements for porting GEDAE™ to a platform is that the TCP/IP protocol and the X windows graphics standard be supported. GEDAE™ uses the Sun standard XDR protocol to provide data translation between various machine types.

3.2.4.2 Application Interface Builder (AIB)

An Application Interface Builder (AIB) has been developed by ATL under the RASSP program to generate the application specific Command Program Interface (CPI) instantiation that fills the gap between the CPI and the Data Flow Interface (DFI). Figure 3.2-1 illustrates this gap.

The control software developer issues a mode change request via the CPI and the interface software constructed by the AIB will provide the detailed sequence of commands via the DFI to implement the request. The CPI instantiation consists of calls to the DFI based on the specific set of modes/submodes for the application, the set of graphics developed to perform the application, and the correlation between the two sets. The capability of the AIB will be commercialized as part of the GEDAE™ product.

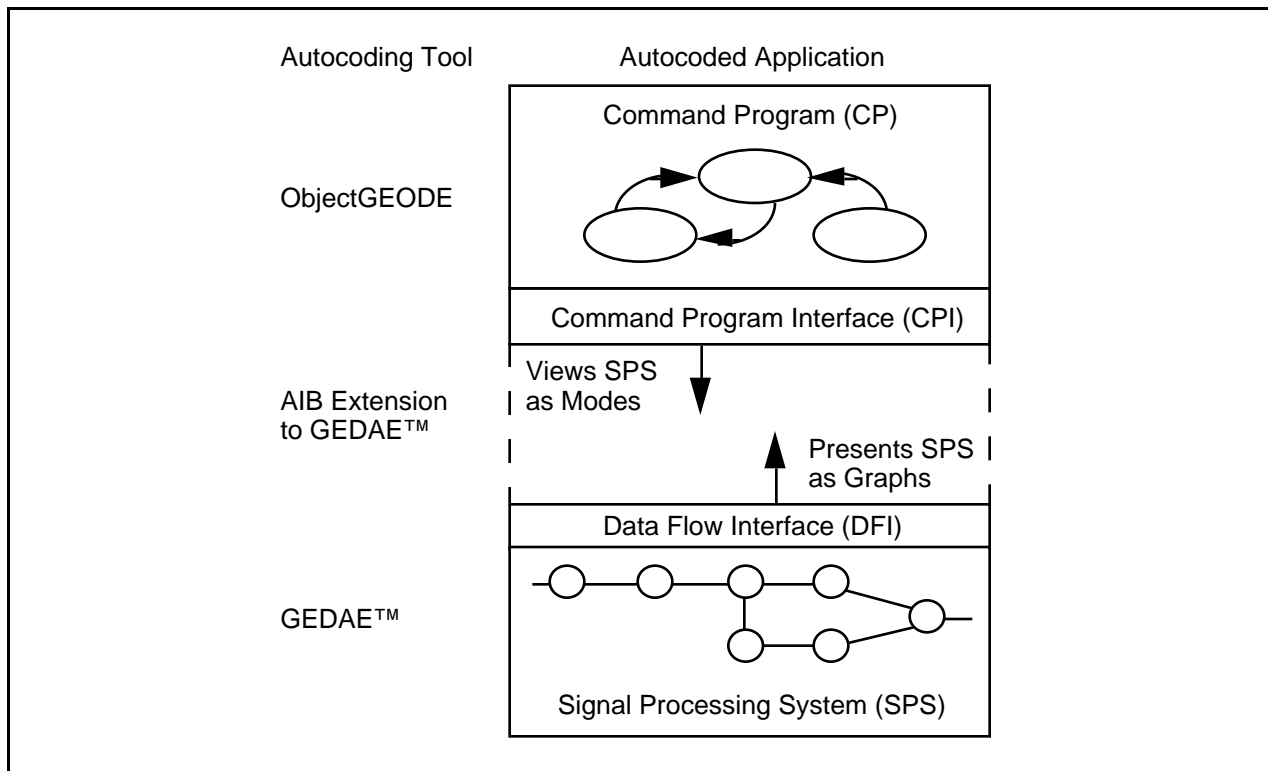

Figure 3.2-1. Application Interface Builder bridges gap between data flow and control flow.

3.2.4.3 PRICE

PRICE is used in conjunction with SavanSys to provide cost estimates for the candidate architectural configurations. The characteristic information derived from SavanSys is used by Price to develop data for the cost/performance trade-off matrix.

3.2.5 Omniview/Honeywell

3.2.5.1 Performance Modeling Workbench (PMW)

PMW, Performance Modeling Workbench, is a GUI front-end and set of postprocessing tools for the HTC (Honeywell Technology Center) PML (Performance Model Library). The PML is a set of abstract VHDL models representing the various network architecture components that comprise a multi-processor DSP system. Such components include generic processor nodes, buses, and network switches. PML resolves the components at the so-called "performance modeling" level, where time related issues such as latency, throughput, and resource utilization are concerned. Application data values are not evaluated by the PML models.

PMW provides a convenient graphical way to configure the purely textual PML models of a hardware system. PMW also provides a graphical method to capture application software in a data-flow-graph that in turn drives the hardware models during simulation. PMW provides a mechanism for building and launching the VHDL simulation and collecting the results. The simulation results are analyzed through PMW's time-line displayer utility.

3.2.6 Management Sciences Inc.

3.2.6.1 RAM-ILS

The Reliability, Availability, Maintainability and Integrated Logistics Support (RAM-ILS) tools are integrated in a UNIX graphics user interface. A second interface has been generated that is embedded in the RASSP design framework. Both graphic user interfaces use connectivity drawings to represent simulation models. The RASSP RAM-ILS toolset consists of tools for pre-design architecture simulation, during design verification and assessment, and component selection for final detailed design. There are tools for success analysis, decision analysis, fault tree analysis, failure modes and effects analysis, availability analysis, reliability analysis, maintainability, and life cycle support costs.

3.2.7 Marconi Systems

3.2.7.1 RTM

RTM provides a requirements engineering toolset designed to ensure that all project work is performed against a customer stated requirement and that requirements traceability, compliancy and quality auditability are maintained throughout a project lifecycle. The RTM project database holds information pertaining to all phases of the project, but focuses primarily upon the system requirements and the tracking of these requirements through the product lifecycle. During the architecture definition process, hardware/software co-design tradeoffs are conducted to determine the architectural entities of the signal processor. The requirements for each of these architectural entities are established during this process and these requirements are traced to the signal processor requirements through the use of RTM.

3.2.8 Alta Group

3.2.8.1 SPW

SPW will be used to explore algorithms and function partitioning issues including assessing the complexity of the required processing. The SPW tool (or the JRS graphing tools with NetSyn) will provide the dataflow graph which drives the multiprocessor design.

3.2.9 Mathworks

3.2.9.1 MATLAB

The MATLAB functions developed in the System design effort will be used to verify the correctness of the architectural implementation.

3.2.10 Precedence

3.2.10.1 SimMatrix

The mixed domain simulation backplane is used when high-risk design elements spawn prototyping activities resulting in more detailed designs running on any one of a number of lower level simulators. The detailed design can then be co-simulated with the higher level architecture simulations for verification.

3.2.11 Mentor Graphics

3.2.11.1 QuickVHDL

The QuickVHDL family of products consists of a VHDL compiler, an interactive simulator, and a VHDL source language debugger. Multiple interactive windows allow a designer to simultaneously view the design hierarchy and VHDL source code, display variable and signal values, control the simulator, schedule processes, and display simulation results in both list and waveform outputs. The simulator, developed by Model Technology, combines the best features of previous interpreted and C-compile methods, resulting in faster throughput (as a function of compile and simulation times). Benchmarks show that the QuickVHDL "direct compile" technology, in which VHDL code is directly compiled to the instructions of the host RISC simulation engine, is between 2-10x faster than other methods.

The current level of integration of QuickVHDL allows a designer to enter VHDL code, compile, and debug compile errors within Design Architect. Graphically-entered structures in Design Architect may also be passed to QuickVHDL and schematic cross probing is supported.

3.2.12 MCCI

3.2.12.1 Autocoding Toolset

The Autocoding Toolset is designed for the development of large, complex parallel signal processing applications that require significant processing power. The toolset contains a set of integrated tools that translate an application specified as a set of PGM graphs into a set of 'C' source code files which are target specific. Applications are specified as data flow graphs using a formal graphical language (PGM) and a target independent library of signal processing routines. The graphs are partitioned into independent execution units which are then assigned to specific processors. Through partitioning, the user can eliminate many execution bottlenecks such as data transfer contention. Processor specific support for target independent signal processing routines is incorporated in the Autocoding Toolset as optimized, target specific implementations of these routines utilizing high performance math libraries from board vendor or third parties.

3.2.13 VERILOG

3.2.13.1 ObjectGEODE

ObjectGEODE from VERILOG enables the generation, verification and validation of target code for the command program

ObjectGEODE can be used to generate a graphical representation of the command program, verify and validate it in a standalone simulation and then automatically generate target code.

The design flow using ObjectGEODE begins with requirements analysis and development of an extended finite state machine model of the system. This model includes objects of the system as well as a representation of external actors. Use-Scenarios are described by means of MSCs (Message Passing Charts). The architecture of the system is then designed using the SDL (Specification and Description Language) concepts of system, block and processes to create an SDL Hierarchical Diagram and a set of SDL Interconnection Diagrams. Test design is performed in parallel with the architecture and detailed design using the Use-Scenarios. The detailed design step consists of specifying states and state transitions at the process and procedure level. The developer rapidly prototypes the application and verifies and validates it using the ObjectGEODE simulator. The code translated from the logical architecture of the system as represented by SDL is partitioned to run either on the system hardware. Actual "C" code is generated which is supported by numerous RTOS including Microtec Research Inc., VRTX, Wind River Inc. VXWORKS, etc. In addition, the 'C' code can also be tailored run using a different RTOS. The tool supports software reuse by easy incorporation of heritage software libraries into both the graphic model and generated source code.

3.2.14 Applied Dynamics International (ADI)

3.2.14.1 BEACON

BEACON converts user specified block diagrams into a variety of software languages, including FORTRAN, Ada and C. It also generates documentation and test vectors for unit tests. The generated software includes on-board diagnostics, performance monitoring, I/O services, startup and shutdown procedures.

3.2.15 Harris Electronic Design Automation

3.2.15.1 Harris EDAnavigator

Harris EDAnavigator is an alternative tool to Savantage's SavanSys. With Harris EDAnavigator, the designer can explore various system-level hierarchical partitioning, packaging design, placement, and interconnect choices with respect to user-selected physical metrics such as electrical and thermal performance and routability without waiting until after layout.

The Harris EDA tool has an advanced partitioning/packing algorithm and will automatically define hardware partitions based on grouping components with maximum interconnect. Harris EDAnavigator does parametric placement based on simulated evolution, minimizing total interconnect, adhering to net-timing and providing congestion avoidance.

3.2.16 Lucent

3.2.16.1 SPEAR

SPEAR will provide a generalized but customizable multiprocessor debugging environment. The tool provides a common user interface to multiple target-dependable debuggers and supports the simultaneous interactions with distributed processing elements for monitoring, controlling, sampling, and instrumenting the multiple processes executing in the target system for the purposes of detecting and localizing errors. SPEAR does not replace the many excellent debuggers targeted to specific commercially available processors and boards, but rather provides a framework within which uniprocessor debuggers may be integrated to support multiprocessing.

3.2.17 University Of Oregon

3.2.17.1 PIE (Performance Instrumentation Environment)

In RASSP there is a need for trace information document the behavior of the system's components. This information is useful for debugging, verification, and testing of both the correctness of the software, as well as its performance characteristics.

The PIE/RASSP system is designed to address the trace generation and visualization needs of the RASSP community. The project consists of two major tools, the PIE/RASSP Event Browser and the PIE/RASSP Development System, that are directed at making the testing and verification process as easy and painless as possible.

The first tool is the PIE Event Browser. This tool is intended to provide much needed visualization capabilities to existing trace generation tools. Many systems rely on developers examining ASCII trace output files or writing custom tools for specific trace formats. The PIE Event Browser provides the developer with a way to quickly visualize any trace output.

The second toolset being developed as part of the PIE/RASSP project is the PIE/RASSP Development System. This toolset represents many man years of development that has been focused on providing the RASSP effort with a DSP application instrumentation, testing and evaluation capability.

3.2.18 Ascent Logic

3.2.18.1 RDD-100 - Refer to Section 2.2.2.

4. HARDWARE DESIGN TOOLS

4.1 Hardware Design Process Summary

The major CAD tools for the RASSP Baseline 2 system are shown in Figure 4.1-1.

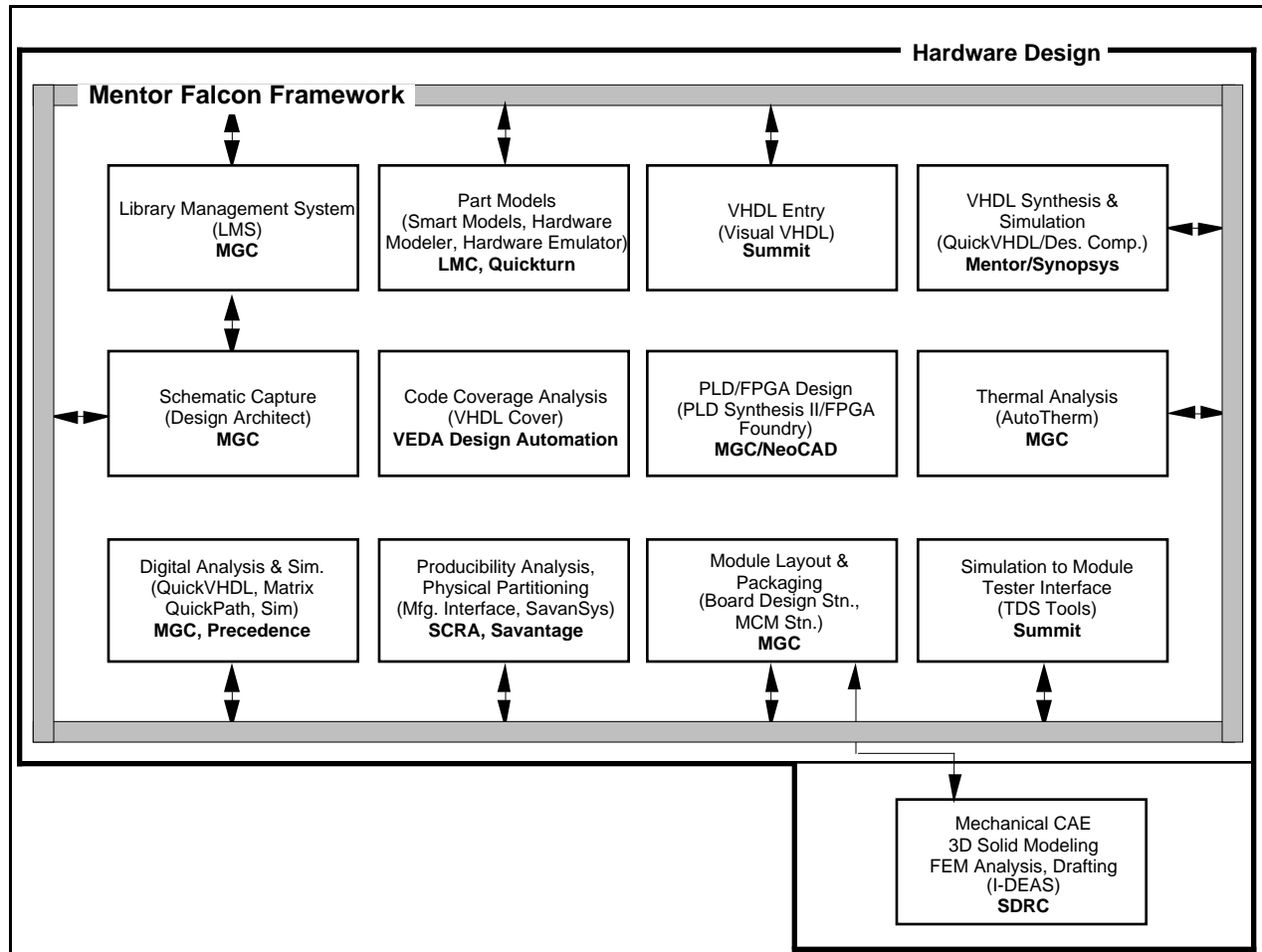

Figure 4.1-1. RASSP hardware design tools.

The major inputs to the hardware design process are:

- Abstract behavioral descriptions of new hardware developments.
- Preliminary parts selection.
- Application or test software that can be used to verify hardware elements under development.

Architecture design defines the top-level hardware architecture and the major elements that go into the detailed design process. The main objective of the detailed design process is to transform the architectural description of the design into the detailed hardware and software components that will be developed, manufactured, and integrated into a prototype processor. As with the prior processes, both hardware and software are verified via a set of detailed functional and performance simulations. When that process is completed, a fully verified virtual prototype of the system exists. The design is first partitioned from the behavioral-level to the appropriate level for all necessary components. Partitioning is driven by component requirements from the Architecture process, with a heavy predisposition toward using library-based components and synthesis of

chip and board-level components from the component libraries. Where at all possible, off-the-shelf modules, MCMs, ASICs, chassis and backplanes will be used. The detailed hardware design process may be invoked at any time during the architectural verification process in order to provide more accurate simulation models for high-risk portions of the design. At the end of the architecture selection process (VP2), some portions of the design may already exist as detailed designs. The overall hardware design process is divided into several distinct, yet interrelated subprocesses:

- Chassis/Backplane design.
- Module Design.
- ASIC/FPGA design (when at all possible, FPGA's should be used for quicker design cycle).
- Subsystem Integration and Test.
- Mechanical design.

These subprocesses proceed in parallel, each providing information to the others. The steps used to develop detailed hardware implementations are as follows:

- Hardware Design Capture using Mentor Graphics Design Architect - The functional elements that are inputs to the process are captured as structural elements from the RASSP component library. New elements are entered at this point as well. The captured schematics are used to drive subsequent pieces of the hardware design process.
- Hardware Partitioning using Mentor Graphics Design Architect and SavanSys - The structural equivalents of the behavioral and component-based designs are partitioned onto boards, MCMs, and chips. These partitions are then combined to form overall signal processing subsystem (boards, chassis, etc.).
- Design Synthesis - Designs can be directly synthesized from RTL or logic level descriptions. Chip synthesis for new ASICs/FPGAs is supported by the Synopsys tool set (Designware, Design Compiler, and FPGA Compiler).
- FPGA Layout - supported by NeoCAD.
- Hardware Design Verification - More detailed simulations to verify the hardware design are performed, including RTL, logic, and analog simulation. These simulators, and links to the behavioral simulation capability are provided by the Precedence "simulation backplane". Hardware emulation capability to speed the simulation process is also supported at this level (Quickturn). Simulations will be performed using VHDL, with simulations using equivalent RASSP library components. Models for new parts at this level will be generated using the bus functional model generator by LMC and by using the graphical VHDL entry tool (Visual VHDL) by Summit.
- Timing Analysis and Test Vector Coverage - Functionally verified logic designs are evaluated for performance using critical path and timing analyses. More robust test vector generation is performed to ensure full node (toggle) coverage. Vectors to provide maximum coverage for the design are generated and verified by VHDLcover by VEDA Design Automation, Inc.
- Layout/Verification - The detailed component and connectivity schematics (board, MCM, and/or chip) are used to generate layouts for the designs. For board and MCM level designs, Mentor's Board Station and MCM Station are used, respectively. FPGA layouts are performed using NeoCAD. Layouts are performed using strict design rules to ensure producibility. These designs are verified using Electrical and Design Rule Checking programs.

- Mechanical/Thermal Analysis - Mentor's Autotherm tool is used to analyze board and MCM thermal characteristics. Mechanical designs are analyzed using the SDRC tool set. Thermal analysis of board frames is also performed by the SDRC tools.
- Fabrication Links/Conversion - Prior to fabrication release, the completed design and layout data is transformed into specific formats required by the selected vendors. Board, chip, and MCM data packages are converted to export appropriate layout, drill hole, and pick and place formats. Test vectors are converted providing tester-specific test patterns by using TDS tools from Summit. The designs are then transitioned to fabrication and test.

The hardware design process transforms the architecture component VHDL models into detailed hardware designs. Abstract, non-evaluated architecture component models are decomposed into full-functional VHDL models of their constituent entities. In addition to the full-functional models, bus-functional models are created where needed to efficiently test interface designs. VHDL structural models are created for the VHDL behavioral models that were developed during the architecture design process. These structural models show the partitioning and interconnection of architecture component modules. Each module is, in turn, further decomposed and partitioned into other modules, macro-cells, MCMs, ASICs, or COTS components. The hierarchical modeling procedure is applied until an entity's constituent units can be either automatically synthesized, obtained from a library either from a previous design, or obtained from a Commercial-Off-The-Shelf library. During the partitioning process, some of the modules, MCMs, and ASICs can be identified as custom parts, while others are selected from COTS parts. For custom-developed parts, VHDL models are developed down to the RTL level, with a fully functional behavior and bus-functional model describing each ASIC. For COTS parts, only VHDL behavioral models are developed or obtained. The VHDL behavioral models describe the timing and functionality of the module, macro-cell, MCM, and/or ASIC.

The test benches developed during the Architecture design process provide the test procedures, stimuli, and expected results to verify that the design meets system requirements. The test benches are executed with the behavioral models of the hardware designs during simulation. The full-functional behavioral model forms the executable specification for a hardware design. We back-annotate the simulation results of the detailed hardware models to the higher level architecture models. A gate-level VHDL description of the design can also be generated and simulated with the test bench. The results of this simulation can be compared with the results of the pre-synthesis simulation to verify that the implementation is correct.

4.2 Hardware Design CAE Tools

The RASSP Hardware Design toolset includes:

- Mentor's FALCON Framework is used to provide a common user interface and data interchange and management capabilities. This framework is used to integrate Mentor tools and third-party applications into a single environment. The Mentor Graphics tools Design Architect, QuickVHDL, QuickPath, and QuickSim II provide design capture, VHDL simulation, critical path analysis, functional simulation, statistical fault grading, and fault simulation, respectively. Physical design of modules is provided by the Board Station, Hybrid Station, and AutoTherm tools from Mentor Graphics.
- SimMatrix from Precedence provides a simulation backplane to support co-simulation using different simulators.
- The System Realizer Family of Modular Emulation Systems from Quickturn Design Systems provides the capability for hardware emulations.
- VHDL is generated using the graphical tool, Visual HDL, from Summit Design.
- Synopsys tools provide an environment for compiling, simulating, and synthesizing design descriptions written in VHDL.

- Programmable Logic Device and FPGA design are supported by MGC's PLD Synthesis II and NeoCAD.
- Hardware modeling capability is provided by the LM Family from the Synopsys Logic Modeling Group.
- SavanSys from Savantage, Inc. is a tradeoff analysis tool focused on packaging and interconnection of high-performance electronic systems.
- Testability analysis and test database translation is accomplished through VICTORY from Teradyne and TDS from Summit, respectively.
- Managing part libraries for electrical design is accomplished through Mentor's Library Management System (LMS) software.
- Mechanical design is supported primarily by software supplied by SDRC. Their I-DEAS Master Series software provides a complete complement of mechanical design capabilities, including thermal analysis, 2D (2-dimensional) and 3D design and modeling, and finite element analysis.
- VHDLCover from VEDA Design Automation, Inc. analyzes VHDL code and determines how thoroughly the design has been tested.
- RDD-100 (Requirements Driven Development) from Ascent Logic is used to capture system requirements, perform functional decomposition, model system behavior, allocate requirements to components, and generate systems engineering documentation.
- Interleaf is the documentation production tool.
- Lucent's SPEAR supports a customizable debugging environment for multiprocessors.
- University of Oregon's PIE is an application and design evaluation environment.
- ObjectGEODE from VERILOG enables the generation, verification and validation of target code for the command program.
- BEACON from Applied Dynamics International (ADI) is an alternative tool to ObjectGEODE. It can be used to generate code for the command program, test vectors for unit tests as well as product documentation.

4.2.1 Mentor Graphics

4.2.1.1 Design Architect

Design Architect is a comprehensive and integrated system for specifying and creating electronic designs at the abstract architectural, detailed logic and circuit levels. As Figure 4.2-1 indicates, Design Architect is the center of activity for most hardware design processes. It lets you create and edit logical designs that are used by downstream processes such as digital simulation and PCB layout. These applications return design information to Design Architect in the form of back annotation values.

Design Architect is a multi-level design environment that includes: a Schematic Editor, a Symbol Editor, and a VHDL Editor. In a multi-level design environment you can:

- Implement top-down and bottom-up design methodology.
- Specify a design at different levels of abstraction, from high-level specifications to gate-level implementation.

- Specify a design with different modeling techniques.
- Configure and manage different design descriptions to explore alternate design implementations.

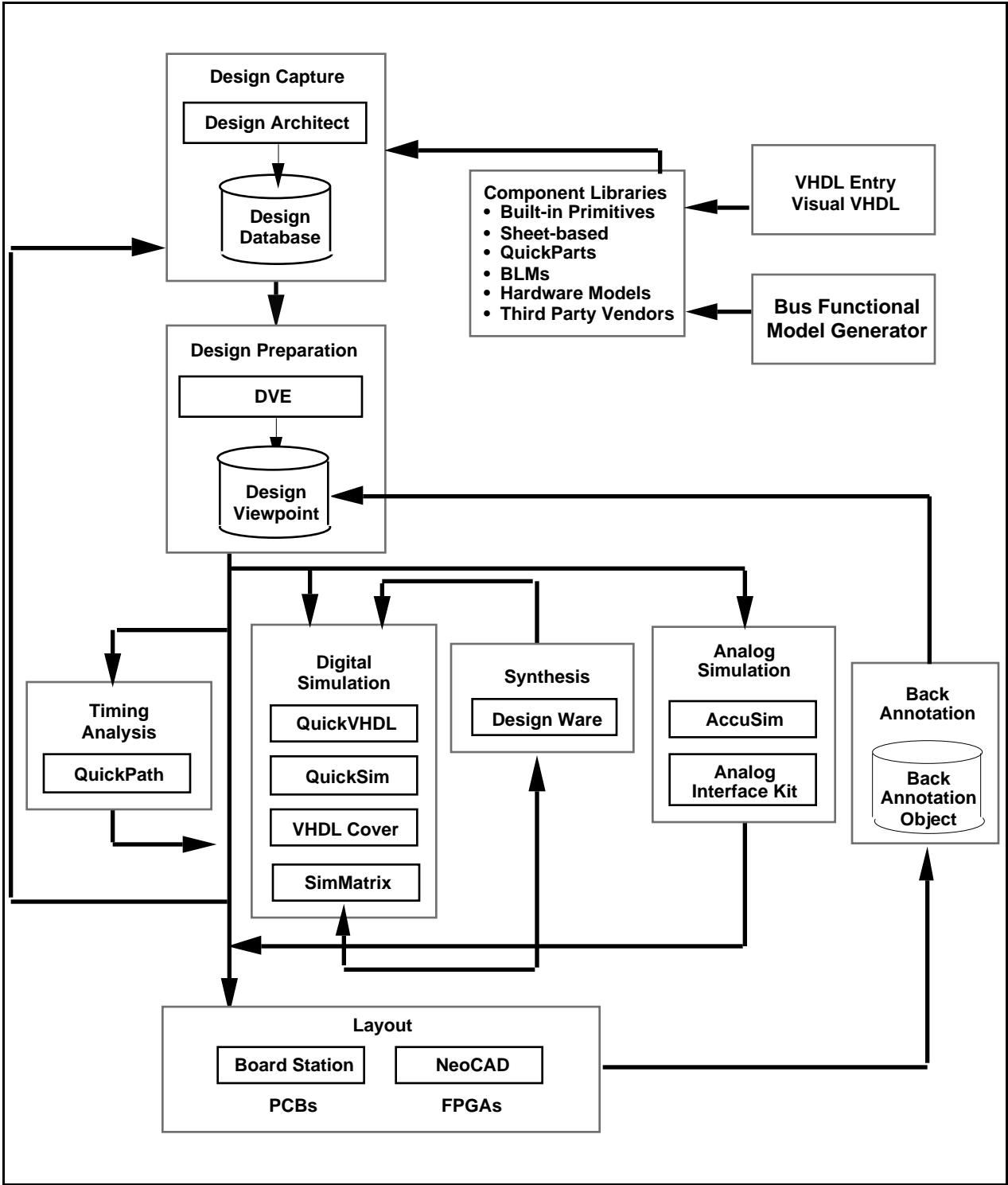

Figure 4.2-1. Mentor IDEA EDA tool set.

See Figure 4.2-2 for a typical Design Architect display.

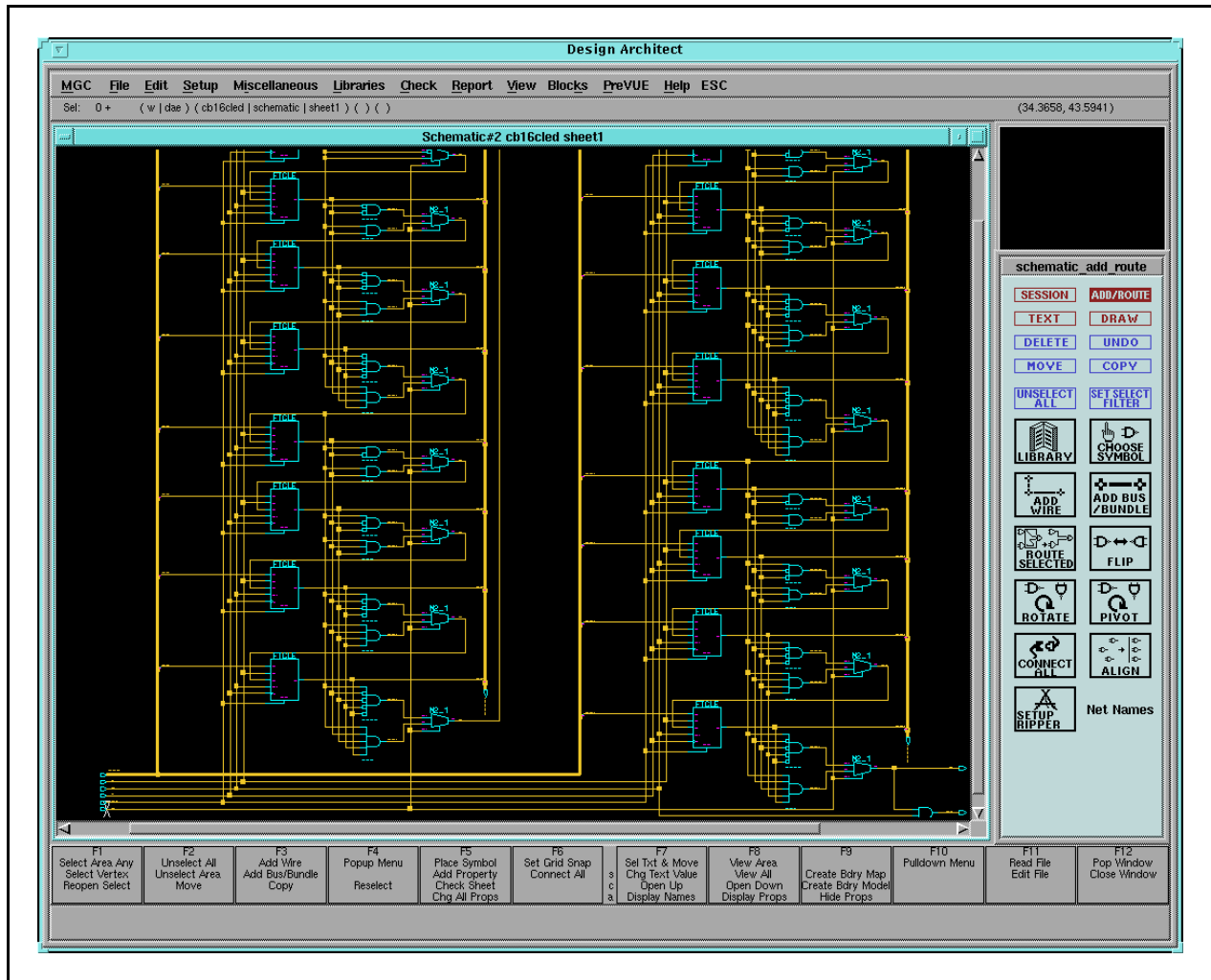

Figure 4.2-2. Design architect screen.

4.2.1.2 QuickVHDL

QuickVHDL allows you to quickly model and test a system at a high level of abstraction. This ability means that you can limit the amount of information that is analyzed at one time to a manageable level. You can also identify and correct many problems before they propagate to the lower gate-level implementations or the breadboard stage. QuickVHDL has the following features:

- Full-featured VHDL simulator supporting IEEE-1076-87, VITAL 2.2b and VITAL '95, enables the industry's widest support from ASIC, FPGA and semiconductor foundries.
- Optimized Direct Compile architecture results in the industry's fastest compile times and simulation performance.
- Optimized Direct Compile uniquely offers design and library portability with machine-independent object code.
- Model support for "C" models, LMG SWIFT-based SmartModel® and Hardware Modeler (LM).
- Source, Structure, Process, DataFlow, Wave, List, Signals, and Variables windows for design analysis and debugging.

4.2.1.3 Library Management System (LMS)

Mentor Graphics component libraries contain a variety of model types, used to describe the behavior of a circuit. The behavioral description of a circuit is necessary to simulate and analyze the circuit's functionality. The behavioral description of a circuit is defined with a functional model. Some examples of functional models are: schematic models, hardware models, Behavioral Language Models, and VHDL models. The designer selects component models from a wide variety of component libraries, and then places and connects these components together to form schematics and simulation models.

In order to capture designs and prepare them for layout in the LMS environment, the following tools and utilities are used:

- Library User – Library User is used by the designer to open new and existing designs, place and connect parts, add or alter properties, update parts, replace parts, check design rules, and save designs. Library User is based on the Mentor Graphics Design Architect (See Section 4.1.1.1) application. Consequently, most of the interface characteristics are identical. However, Library User incorporates several features that facilitate design creation in LMS:
- A Part Selector for finding and placing parts from libraries created and maintained by the librarians.
- A palette and matching popup menu that adds part selection shortcuts to the Part Selector.
- Schematic editor menu items that adapt Design Architect's part placement, part updating procedures, and part replacement features to support and maintain LMS part structure. This editor also supports catalog entry viewing, pin number setting, and other operations. The Part Selector lets you navigate the hierarchy of parts menus to locate parts you want to place in a design. One feature the Parts Selector offers is the "shopping list". Through use of Part Selector palette icons or popup menu items, you can create lists of parts that can either be immediately placed or retained as parts lists from which you can select and place parts at a later time during the Library User session. The "shopping list" feature is ideal when you need several parts that come from various areas of a menu's hierarchical structure.
- Design Manager - Manages designs and design data. This application allows a designer to invoke design creation tools, design analysis tools, board PCB design tools, and manage design data. (See Section 4.3.1.2 for more details).
- design_replace - A utility that replaces existing parts in a design with parts from a general "replace list".
- to_layout - A utility that prepares a design for layout through an automated packaging process.
- design_update - A utility that updates parts in a design on a design-wide basis.

4.2.1.4 PLD Synthesis II

PLD Synthesis II is a complete, universal programmable logic device development tool. It supports the following:

- Describing a design using the most suitable method for your application--high-level behavioral language (state machine, truth table, or equations) or schematic.
- Optimizes and reduces a design to the smallest set of gates using industry-standard methods.
- Simulates functionality of a design while it is still in the design phase, before committing to hardware.

- Automatically selects devices based on design criteria. It maps a design into various device architectures and presents the best solutions to choose from.
- Allows choice of automatic or manual placement of input and output signals in the selected programmable devices including fitting the design across as many as 20 devices.
- Supports programming of devices using automatic fusemap generation and device programmer communications.
- Gives ability to test programmable devices by generating test vectors from the functional simulator's results and downloading them to the programmer with the fusemap file.

Integration with the Mentor environment provides the ability to export schematics to PLD Synthesis II, to provide automatic simulation modeling that can be exported to QuickSim II for module simulation, and support hierarchical design integration where elements at the top level of a design can be schematic, VHDL, behavioral language, or netlist.

4.2.1.5 QuickPath

QuickPath is a static timing analysis tool which verifies circuit timing by adding up propagation delays along paths between clocked elements in a circuit. This method checks the sums against the specified timing constraints for each circuit path and reports any existing timing violations. QuickPath is a graphical timing analysis tool that reports timing violations on all circuit paths. QuickPath prevents false error reporting by allowing the user to remove “uninteresting” paths from an analysis. In QuickPath, a designer can strategically disable the component pins that these paths pass through and cause the paths to be ignored during an analysis session. In addition, a designer can limit the analysis on several parameters and block uninteresting or invalid paths to reduce analysis time and thus avoid unwanted analysis results. QuickPath does not require stimulus vectors or models that describe the functional behavior of a component but performs an analysis by using pin-to-pin timing information. Timing information can be assigned to any component in the design, or it can be assigned hierarchically to a logical block of the design to reduce the level of analysis QuickPath performs and therefore speed the analysis process. As shown in Figure 4.2-1, QuickPath is integrated with other IDEA Series tools that are used in the design creation and analysis process.

QuickPath is used to perform worst-case static minimum/maximum (min/max) timing analysis on a design. Input signal arrival times and clock information can be specified for the circuit. The clock information includes the clock period, number of clock phases, the clock edge times, and any clock skews. QuickPath uses this information to correctly identify the worst-case clock and signal relationships for accurate verification of circuit timing. In addition, QuickPath determines worst-case paths by using the correct combination of fast and slow components in clock and data paths and considers special circuit conditions (such as the occurrence of common ambiguity) during the analysis process.

Graphics windows display views of schematic sheets and specific paths within the circuit. The selection of an item highlights it within all windows in which it appears, in order to easily locate and view problematic circuit elements within a path or schematic sheet.

4.2.1.6 Board Designer

Board Designer provides full design, documentation, and manufacturing capabilities for printed circuit board (PCB) designs. Figure 4.2-3 shows the workflow through the PCB products. There are five main PCB tools and libraries:

- Librarian is a general purpose graphics editor for defining and modifying geometries in the PCB Geometry Libraries. After identification and completion of all the geometries required by a design, these geometries are compiled for input into layout.

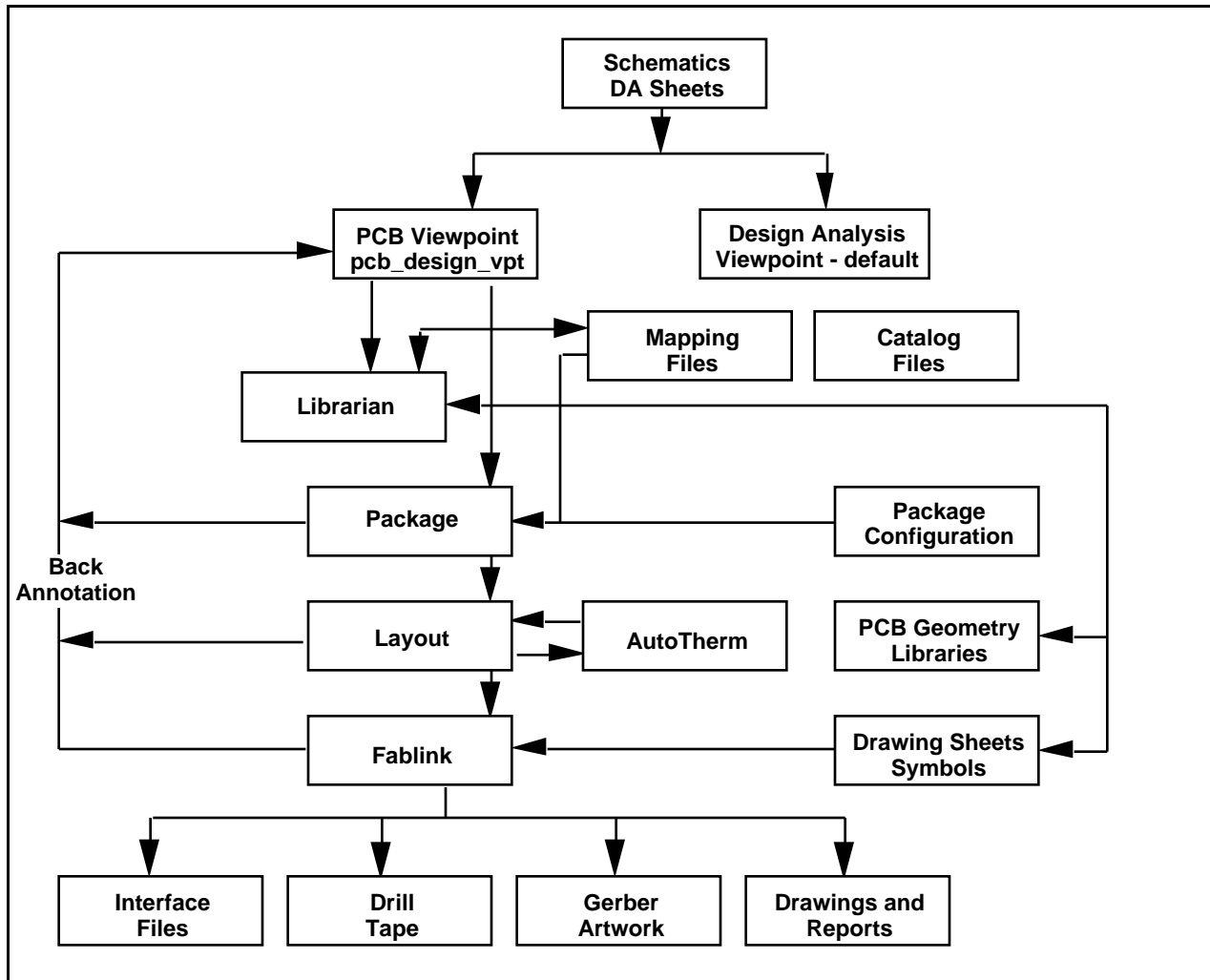

Figure 4.2-3. Board designer process flow.

- Geometry Libraries contain the physical descriptions of the component packages to be placed on the PCB. Graphic descriptions include DIPs, resistors, capacitors, connectors, memory parts, and other component packages.
- Package provides interactive and automatic mapping of schematic symbols to the appropriate physical components. With the use of data in catalog directories, Package generates the components, gates, nets, and pins design objects that drive the rest of the design process. It can also create this design data with a text editor or with translation programs to drive a design through the layout process.
- Layout provides placement and routing of the PCB. Interactive and automatic placement features help place components on the board according to designer specifications and optimize the placement for routing. Likewise, interactive routing features allow routing and protecting critical connections, and automatic routing features can be used to route the rest of the connections. Layout includes the Dynamic Editor used for trace editing. The Dynamic Editor employs interactive features to help you in the last stages of board routing.
- Fablink is used to generate manufacturing data and documentation for a PCB design. The manufacturing data includes files containing instructions to drive photoplotting, drill, and milling machines. The documentation includes fabrication and assembly drawings, and bills of materials.

4.2.1.7 AutoTherm

AutoTherm is an interactive, finite-element based software tool that performs thermal analysis of printed circuit board assemblies. AutoTherm operates within the Mentor Graphics Common User Interface (CUI) environment. The CUI brings a common look and feel to Mentor Graphics applications. AutoTherm uses a single view display. AutoTherm features and capabilities provide ways to improve a printed circuit board design. Within a PCB, AutoTherm models steady-state and transient heat transfer in the following modes:

- Conduction
- Convection
- Radiation

AutoTherm also allows you to model non-viscous fluid flow, which can be used for analyzing flow velocities for forced convection problems. In a few easy steps, you can accurately:

- Simulate heat transfer in a PCB assembly.
- Derive useful graphical results.
- Gain insight into the thermal behavior of a particular PCB Junction-to-case and junction-to-board. Thermal resistances of individual parts can also be modeled within AutoTherm.

4.2.1.8 MCM Station

MCM Station supports multichip module design with integrated high-speed layout tools and advanced packaging techniques and crosstalk analysis.

4.2.2 Synopsys

The Synopsys tools provide an environment for compiling and simulating descriptions written in VHDL. They provide capabilities for source-level debugging, displaying the results of simulations, and performing analysis on these simulation results. It also provides interfaces to C-language models, the LMG SmartModels Library, DesignWare Libraries and Zycad XP Accelerators.

4.2.2.1 VHDL Compiler

The VHDL Compiler converts VHDL source code to an internal format used by the Synopsys Design Compiler. VHDL Compiler performs two functions: translating VHDL to an internal format, and optimizing the block level representation through various optimization methods.

4.2.2.2 Design Compiler

The Design Compiler reads the design from VHDL Compiler, then optimizes and maps the design's logical structure for a specific ASIC technology library. The user determines how much of the design will be restructured by Design Compiler. The design hierarchy can be left intact, modules can be combined, or the entire design can be compressed into one module. In Design Compiler, the design can be written out in a variety of formats, including VHDL. Existing gate-level netlists, sets of logic equations, or technology-specific circuits can be automatically converted to a VHDL description. The new VHDL description can serve as documentation of the original design. Furthermore, it can be used as a starting point for reimplementing into a new technology. In addition, the VHDL description can be input to a VHDL simulator to provide circuit timing information.

4.2.2.3 DesignWare

DesignWare Developer, part of the DesignWare product family, lets you create DesignWare components from your own design data. The DesignWare family of products includes tools for a design reuse strategy that leverages the capabilities of Synopsys synthesis, simulation, and test and supports the Model Year Architecture methodology of the RASSP program. DesignWare components are verified design units that have been provided with hooks for integration into the Synopsys synthesis environment.

A DesignWare component consists of verified, synthesizable design description(s). The style of description can vary from a technology-specific netlist or hard macro that will not be altered by synthesis, up to a full hierarchical HDL description of a parametrizable, optimizable design. One of the main advantages of DesignWare is that many different design descriptions (different implementations) can be created for a given function; the designers can let the synthesis tools choose which implementation to use in any given context. Modeling directives applied to the design descriptions control how Design Compiler models the designs during implementation selection. To characterize the implementations for comparison, the synthesis tool creates a preoptimized model for each implementation in the target technology. The timing and area characteristics of the models serve as the basis for implementation selection. The chosen implementation is inserted, by default, as a level of hierarchy in the user's design, which is then mapped to the target technology and optimized. Compilation directives control how (and whether) Design Compiler optimizes the DesignWare component during the optimization of circuits that contain the component. Licensing directives protect the designs from unauthorized use.

When a designer includes an instance of a DesignWare component in a circuit, the component undergoes a chain of transformations when the circuit is synthesized. The process starts with a simple HDL construct--an operator or a component instantiation--supplied by the designer. The final result depends on the nature of implementation the tools select as the best: for synthesizable HDL, the result is an optimized netlist in a particular technology; for a macro, the result is simply an instance of the macro. Design Compiler includes FPGA compiler which provides features intended for high-performance FPGA implementation. The FPGA Compiler supports FPGA-specific optimizations. For Xilinx 4000 series designs, FPGA Compiler supports CLB and IOB cell optimization. The Design Compiler family of products read in and optimize designs in a variety of design formats. These designs can be hierarchical or flat, combinational or sequential. After a design is read in, Design Compiler can optimize it for timing, area, and power (for ECL designs), then mapped it to a target (cell) library. The ECL Compiler supports ECL-specific optimizations, such as creating wired logic. The FPGA Compiler supports FPGA-specific optimizations. For Xilinx 4000 series designs, FPGA Compiler supports CLB and IOB cell optimization. The optimized design can be written out in a variety of design formats. Design Compiler also provides links to CAE/CAD tools (such as place-and-route) and post-layout resynthesis techniques (such as in-place optimization). CAE/CAD tool links provide a mechanism for information such as forward-directed constraints and delays to be read between Design Compiler and external tools.

4.2.2.4 SmartModel Library (Logic Modeling Group)

The SmartModel Library is a collection of behavioral models that offer the advantages of fast simulation and minimum memory requirements. Built into each model are many checks designed to detect specific usage errors that are likely to occur when designing with a particular part. In addition to the basic logic simulation features of the library, it also supports Mentor Graphics fault simulation and timing analysis (QuickPath). The library provides thousands of models including popular microprocessors, FPGAs, PLDs, DSPs and complex VLSI components.

4.2.2.5 LM Family Hardware Modeler

Once an integrated circuit or MCM has been obtained from the manufacturer, it can quickly be used as a hardware model. A simple "Speed-Model" of the device can typically be created within

a few hours. A more elaborate Logic Model, including timing information, can be created within a day. Functional verification can then be performed on the ASIC prototype to verify the ASIC design and fabrication. See Figure 4.2-4 showing the LM Family applications in the design cycle.

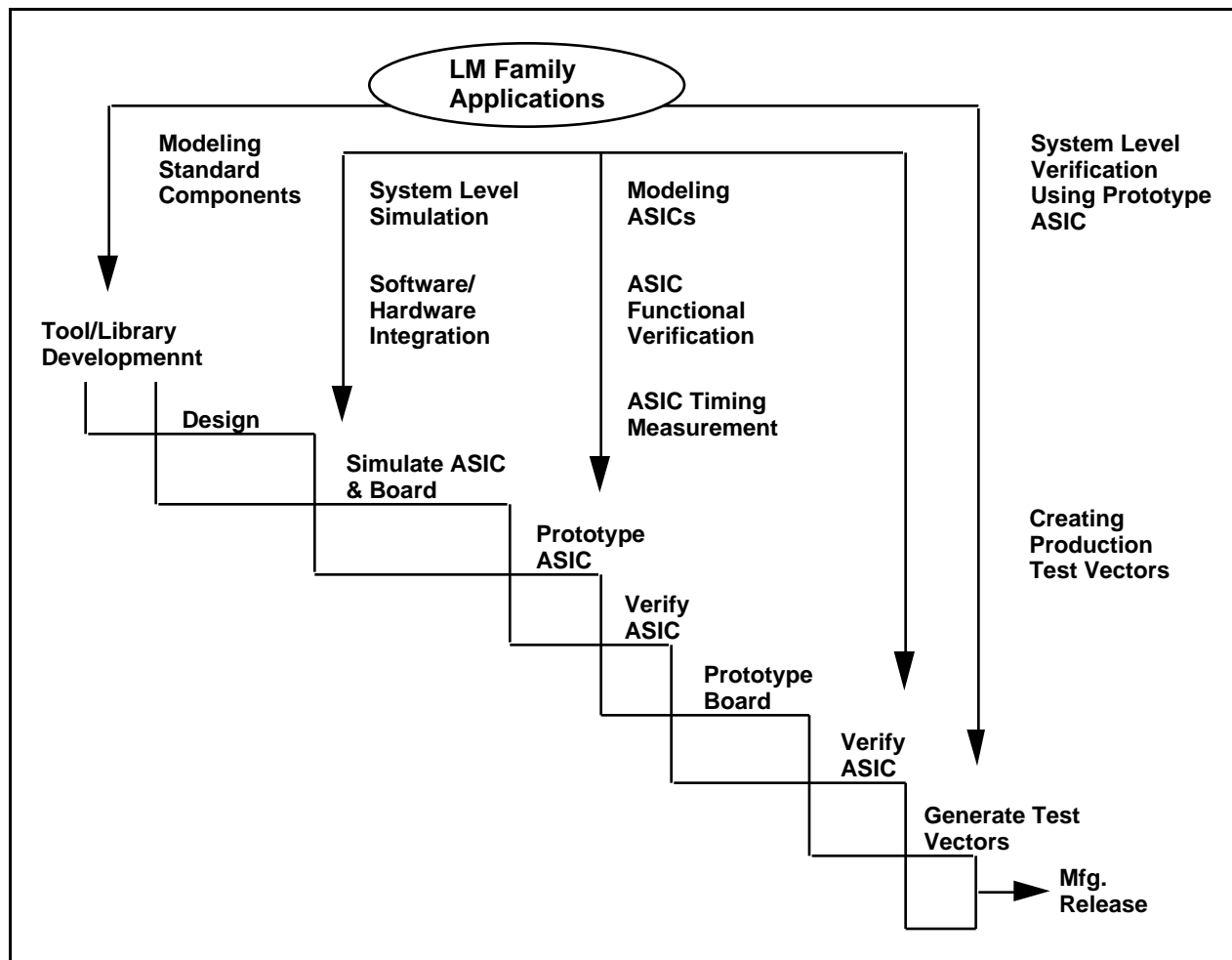

Figure 4.2-4. LM Family usage in the design cycle.

The LM Family modelers can be used to perform software/hardware integration by executing software on a simulated design before investing in prototype hardware. Sections of code can be compiled and stored in simulated memory. This storage allows the use of diagnostics, test, or application software as input to the simulation to verify the hardware design. The accuracy of the Logic Model ensures that if the tests complete successfully, the hardware will work.

The accuracy of Logic Models improves the overall accuracy of the simulation, and it improves the performance of the modeler during simulation. Since the modeler is controlled by the simulator, the designer needs to learn only the simulator's user interface. System-level simulation using the LM Family modelers is of particular benefit when designing ASICs. Before ASIC fabrication, system-level simulation (using Logic Models for standard components and for existing ASICs) verifies ASIC performance in the system. While chip-level simulation (the simulation of the device on its own) verifies the internal functions of the ASIC, only system-level simulation can verify the functionality of an entire system, including multiple devices or even multiple boards.

Using the modeler, a designer can functionally verify prototypes without any specialized knowledge of tester formats, using the familiar simulator interface or the "Play Vectors" utility to apply test inputs and compare results. In addition, the LM Family's timing measurement

capability allows the designer to measure the actual delays on device pins identified as outputs and I/Os, to an accuracy of +/- 2 ns or +/- 2% of the measured delay.

The LM hardware modeler supports System-level verification with a prototype ASIC. Once a Logic Model of the ASIC has been created, it can then be used in performing a complete system simulation prior to creating the system prototype. The Logic Model in the simulation verifies the behavior of the ASIC in the system, speeds the simulation (since the hardware model is used in place of a gate-level representation), and helps to create additional ASIC test vectors. Worst-case simulation with minimum/maximum delay values can be performed using the Logic Model of the prototype; final silicon is not required, because delays may be read from a user-provided timing file.

The modeler hardware consists of the following elements:

- CPU with system memory - Executes the runtime modeler software and provides Ethernet support.
- Timing Generator - Generates the precision timing signals for the system.
- Pattern Controller - Controls the high-speed presentation of pattern history.
- Fast Pattern Memory - Stores the pattern history to be presented to a device.
- Pin Electronics Module - Contains the pin drivers and sampling circuitry for the Logic Model. Each Pin Electronics Module supports 80 device pins.
- Device Adapter - Contains the device being modeled and interfaces it to the Pin Electronics Module.
- Diagnostic Adapter - A special Device Adapter used to verify the correct operation of the hardware modeler.

LM Family Software - The LM Family modelers software is composed of the Runtime Modeler Software and the Host Computer Software. The LM Family's Runtime Modeler Software is the software that controls modeler operations and provides the main modeler functionality. The Runtime Modeler Software is downloaded from the host system and executes on the modeler. It includes the network support software for the modeler as well as the modeler control software. The Host Computer Software executes on the host system and includes the following:

- Simulator Function Interface (SFI) - The SFI module is linked with the simulator and allows the simulator to communicate with the modeler.
- Utilities for modeler management and special applications - The Utilities execute on the host and handle modeler booting, diagnostics, model syntax verification, and modeler configuration and usage reports.

Logic Models are complete and ready-to-use hardware models for use with the LM Family modelers. Each Logic Model consists of the following:

- Model Hardware - The physical device mounted on a Device Adapter.
- Shell Software - The set of text files that provide information about the device, such as the pinout and timing. Test vectors are also included for use.

4.2.2.6 VHDL Models (SourceModels)

This library contains SSI, MSI and memory components, including a VHDL Test Bench with each model.

4.2.3 NeoCAD

4.2.3.1 FPGA Foundry

NeoCAD's FPGA Foundry is a device-independent toolset for the implementation of Field Programmable Gate Arrays (FPGAs). Design entry can be via an HDL program or the Mentor Graphics Design Architect schematic capture package with one of the supported libraries (NeoCAD, Xilinx, Actel, or any Viewlogic library). NeoCAD will accept a number of industry-standard netlist formats. FPGA Foundry translates the design into the NeoCAD device-independent database, maps the logic into a target architecture. FPGA Foundry PAR implements the design using an advanced, timing-driven place and route tool. With the timing-driven capability the user is able to specify timing preferences (clock frequency, net delay, path delay, skew) which are used during the place and route process to give the user the desired solution with fewer iterations. NeoCAD EPIC (Editor for Programmable ICs) is an advanced device-independent graphical editor which allows the user to view and alter the implemented design. FPGA Evaluator lets the user assess the viability of many different FPGA device alternatives in a single, consistent design environment. Assisted Device Selection performs a physical mapping of the design to each selected architecture. This determines whether the design will physically fit into the selected devices. Assisted Speed Grade Selection performs a static timing analysis of the design in each family and speed grade to determine which speed grades are most appropriate for the design. The analysis is performed based on the user's timing constraints. Finally, the timing-driven place and route can be performed on each candidate device.

4.2.4 Summit

4.2.4.1 TDS (Test Development Series)

The TDS software system is designed to provide all the tools needed to manage the behavioral data associated with an electronic product development cycle. With TDS, data is generated, reformatted, stored, analyzed, modified, and transformed into test programs to support all phases of design and production.

Data can be used from many sources. Data from most simulators can be processed and existing test programs can be used as a data source. Data can be viewed with the TDS tools and then quickly analyzed for completeness and adherence to specifications. In addition, the capability to check data compatibility with the intended tester.

Modifications of the waveforms including adding or adjusting timing information, aligning signal edges, eliminating unnecessary pulses, and eliminating hazardous test conditions can be accomplished. Output can be generated for resimulation or for production of high quality test programs for the tester of choice.

The TDS software system consists of many modules. The components of the TDS software system are:

- ASCII I/O Interface - inputs and outputs waveform data in a standard format for the user's proprietary tools.
- Conditioners - modify SEF (Standard Event Format - one of Summit's internal databases) to solve tester compatibility problems or to add device specification information.
- In Converters - accept simulation data and reformat it into waveforms in the SEF database.
- Out Converters - output waveform data as simulation force files for resimulation.
- Test Program Emulators - generate waveform data from existing test programs.

- Test Program Generators (WaveBridge) - output test programs generated from timing and waveform data from separate sources.
- Simulation Rules Checker - analyzes waveform data for compliance to user-specified rules.
- Utilities - permit the display, printing and analysis of waveform data from the SEF.
- SEF Database - holds the behavior information as unstructured events (wave data without timing).
- Waveform Database - holds the behavior information as structured events (wave and timing data).
- WaveMaker - provides graphical editors to modify WDBs (another Summit data format) and allows creation of graphical job flow scenarios that use other TDS modules.

4.2.4.2 Visual HDL

Visual HDL provides a complete design environment for system designer, ASIC designers, FPGA designer, and simulation model developers. Designs are entered graphically and verified through simulation and debugging. Designs may be entered using block diagrams, state diagrams, flowcharts, and truth tables. The output is synthesizable VHDL code.

4.2.5 Precedence

4.2.5.1 SimMatrix

The SimMatrix co-simulation products from Precedence allow the designer to perform system level simulations in a heterogeneous design verification environment such as the one required for the Architecture Verification and Detailed Design portions of the RASSP design cycle. System level simulations frequently need models represented at different levels of the design abstraction hierarchy. The SimMatrix technology allows simulations combining gate-level, accelerated gates, emulated gates and VHDL all in a common design environment.

Designs utilizing two or more simulators, such as the QuickVHDL simulator from Mentor and the Quickturn emulator, are hierarchically partitioned within the original design environment. During co-simulation, the backplane transparently manages the flow of information and orchestrates synchronization between the simulation algorithms, ensuring high performance as well as flexibility. The graphical and textual user interface and debugging environment of each simulator is preserved and available to the designer.

4.2.6 SDRC

The I-DEAS Master Series suite of mechanical CAE/CAD/CAM tools includes (but is not limited to) the following:

4.2.6.1 Master Modeler

The Master Modeler is a high performance 3D design system and the multi-purpose geometric modeling foundation of I-DEAS. The solids-based approach aids design productivity by easing construction of complex geometry, facilitating design changes, automatically removing hidden lines, directly calculating mass properties, and providing an accurate part definition for NC (numerical control) machining. The SDRC data management system maintains associativity between the master model, drawings, finite element models, and NC (numerically controlled) data.

4.2.6.2 Sheet Metal Design

Utilizing the variational solid modeling capabilities of Master Modeler, Sheet Metal Design software automatically incorporates user-definable bend tables, stress reliefs, and shrinkage allowance into solid models to facilitate rapid design and evaluation of sheet metal parts. A catalog of sheet metal features including punches, tabs, and other features allows the designer to add final detail to the part to capture true design intent. The solid sheet metal model can be unfolded and used to create fully associative flat pattern production drawings, and numerical control tool paths for manufacturing.

4.2.6.3 Drafting

I-DEAS Drafting is used to create detailed production mechanical drawings. It can be implemented as a tool for documenting solid models created in Master Modeling or as a standalone 2-D drafting system. It is seamlessly integrated with the other I-DEAS modules and utilizes the Dynamic Navigator style of user interaction. Orthographic, section, detail, and auxiliary views are easily created from the master model.

4.2.6.4 Tolerance Analysis

I-DEAS Tolerance Analysis software provides the capability to evaluate the tolerance specifications of a design to reduce the chance of assembly interference problems. It uses variational geometry techniques to determine worst case and statistical tolerance stack up between mating parts in a complex assembly. A user can measure the sensitivity of a critical dimension in an assembly to changes in individual constraints. Tolerance models are created by relating fully constrained 2D variational sections or wireframes.

4.2.6.5 Mechanism Design

I-DEAS Mechanism Design software is an integrated capability for simulating complex motion of articulated mechanisms. Using assemblies created using Master Assembly, joint constraints and connectivity information are created, and motion and loading inputs are applied. I-DEAS then calculates resultant forces, motions, and velocities.

4.2.6.6 View and Markup

View and markup is used by checkers to check the final drawings from I-DEAS Drafting, or by design review teams to evaluate designs from I-DEAS Master Modeler. An integrated Geometric Dimensioning and Tolerancing syntax checker simplifies the drawing checking task. It provides for drawings to be marked with notes, new geometry added, wrong geometry crossed-out, and dimensions highlighted.

4.2.6.7 Finite Element Modeling

I-DEAS Finite Element Modeling (FEM) software provides comprehensive capabilities for building finite element models and reviewing analysis results. It uses the Master Modeler geometry directly, and includes the fundamental modeling functions of automatic mesh generation, application of loads and boundary conditions, and model checking. Post-processing functions allow the recovery of analysis results and provide extensive graphical and numerical tools for gaining an understanding of results. A rules-based Simulation Advisor is available to guide the user through the analysis process.

4.2.6.8 Optimization

The Optimization software assists the user in the use of analysis results to directly drive design improvements. Structural optimization can help weed-out poor design concepts as well as identify and improve promising ones. It can also be used for fine-tuning designs by minimizing

weight or cost, while insuring they will meet all structural performance requirements. Optimization uses the finite element analysis approach to simulate structural performance.

4.2.6.9 System Dynamics Analysis

I-DEAS System Dynamics Analysis software provides an interactive, graphics oriented capability for simulating the dynamic performance of mechanical systems. The user can model a mechanical system, analyze its modal parameters, and evaluate its response to applied forces and enforced motions. System models may be assembled from components defined from FEA analysis, solid modeling, as well as experimental modal analysis.

4.2.7 Quickturn

4.2.7.1 System Realizer Family

Quickturn's System Realizer Family of Modular Emulation Systems and the Logic Animator rapid prototyping system are used to generate a reprogrammable physical prototype, or "virtual silicon" representation, of their electronic circuit designs. This representation is then available for concurrent verification of the entire target system, including system software and applications, and iterative design changes, all prior to silicon fabrication.

4.2.8 VEDA Design Automation, Inc.

4.2.8.1 VHDLcover

VHDLcover provides code coverage analysis for VHDL code. Simulation verifies that the portion of code being tested works correctly. VHDLcover analyzes the code and indicates how thoroughly the design has been tested and what portions have not been tested. It provides insurance that every line of VHDL code has been tested and redundant code is eliminated.

4.2.9 Teradyne

4.2.9.1 VICTORY

Teradyne's VICTORY software fully automates test generation for boundary-scan devices in boards or modules using full or partial scan technology. For individual boundary-scan parts, VICTORY automatically generates in-circuit test patterns. For boards or modules with full networks of boundary-scan parts, VICTORY generates interconnect test patterns that provide 100% pin-level fault coverage. VICTORY also supplies tools for testing the internal logic of boundary-scan devices and for testing conventional devices or device clusters, using the scan cells connected to their inputs and outputs as virtual channels.

VICTORY generates four kinds of scan tests: boundary in-circuit tests, virtual interconnect tests, virtual component/cluster tests, and boundary functional tests. VICTORY diagnostic software helps resolve boundary-scan faults during test. VICTORY also provides Access Analyzer software to help engineers optimize boards for testability, cost, and performance before layout begins.

The boundary in-circuit tests provide automatic generation of boundary in-circuit test (BICT) patterns using information from a BSDL (Boundary Scan Description Language) model, correct analysis of device constraints like pins tied to power or ground, pins tied together, or pins without physical access, automatic detection of stuck-at pins and interconnect opens without manual probing, and automatic disabling of the boundary-scan chain during in-circuit testing.

Virtual Interconnect tests (VIT) provide automatic generation of test patterns for 100% pin-level fault coverage, automatic detection and diagnosis of stuck-at pin faults and shorts and opens between boundary-scan parts without manual probing, automatic detection of shorts between boundary-scan nets and conventional logic nets that have bed-of-nails access, and automatic

conversion of parallel patterns into serial, tester-compatible format with comments for simplified debugging.

Virtual component/cluster tests (VCCT) provide virtual bed-of-nails controllability and observability for testing non-scan circuitry without physical access, automatic serialization of parallel test patterns for testing individual non-scan devices or clusters of non-scan devices via the boundary-scan path, automatic organization of bit-level data for synchronous application via a combination of real and virtual channels, and simplified circuit initialization by direct forcing of inputs to desired states.

Boundary functional tests (BFT) provide thorough testing of the test access port (TAP) and 1149.1 registers, automatic testing of core device logic through the TAP using the new Serial Vector Format (SVF) interchange standard, compatibility with test techniques such as INTEST, BIST, and internal scan, made available by the device designer, and dynamic testing of device performance by applying built-in-self-test (BIST) instructions via the scan chain where the system clock is used.

4.2.10 Ascent Logic

4.2.10.1 RDD-100 - Refer to 2.2.2.1.

4.2.11 Savantage

4.2.11.1 SavanSys - Refer to 3.2.2.1.

4.3 Hardware Design Tool Integration

4.3.1 Framework (Mentor's FALCON)

The FALCON Framework is a common environment in which all Mentor Graphics and OpenDoor applications run. These applications use the FALCON Framework to provide a common user interface, text editor, and decision support system. See Figure 4.3-1 for a diagram of the FALCON components. The FALCON Framework consists of the following.

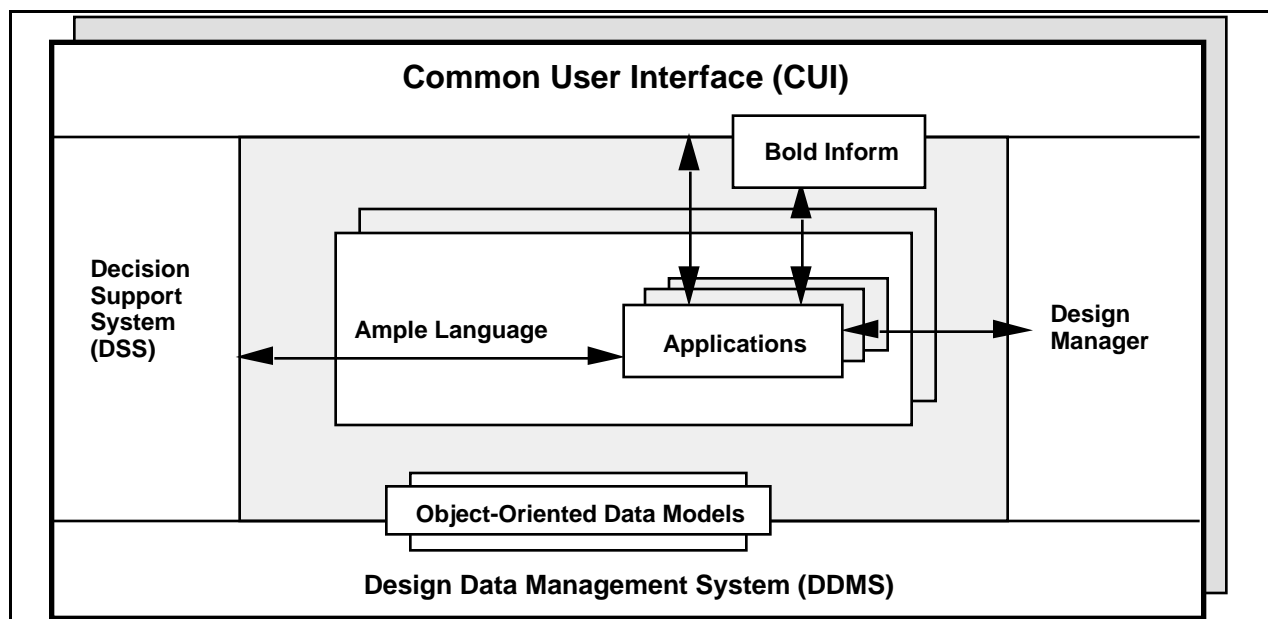

Figure 4.3-1. FALCON Framework components.

4.3.1.1 Common User Interface

The user interface that is used in all Mentor Graphics applications; it supports Open Software Foundation (OSF)/Motif standards to maintain a similar look and feel to all aspects of the user interface.

4.3.1.2 Design Manager

Design Manager is an application that allows you to view and navigate your design data; move, copy, and manage your data; and invoke applications. The Design Manager manages design objects. Design objects are related sets of files and directories that describe different aspects of the design. Each design object includes a set of object attributes, including identity, type, version, and properties.

4.3.1.3 BOLD Browser

BOLD Browser is an application that displays on-line documentation and help information.

4.3.1.4 Notepad

Notepad provides a text editor that operates in a window of any application. Notepad is a text editor that includes easy-to-select font sizes and styles, search-and-replace capabilities, auto-wrap, auto-deletion, and file manipulation. Notepad is programmable and has a large set of user-callable functions.

4.3.1.5 Decision Support System (DSS)

DSS is an application, and a tool on which you can build your own applications, that can be used to access and analyze design data, and to manage design processes. The DSS architecture has three main features:

- Spreadsheet-like interface.
- Visual gadgets for creating prototypes or data-monitoring control panels.
- Interfaces to external design data.

4.3.1.6 AMPLE

AMPLE is a powerful extension language that supports customization and integration throughout the FALCON Framework and all FALCON-based applications. The FALCON Framework is an open framework. This means that you can add your own applications and data to the framework and have them share many of the features of the FALCON Framework environment. Many third-party developers also have versions of their applications designed to run in the FALCON Framework. AMPLE supports structured, procedural programming with a rich set of data types, operators, control structures, and procedural interfaces. Using AMPLE, the Common User Interface can be customized and extended. Support for concurrent engineering and rapid application prototyping are available through AMPLE and DSS. Design applications integrated within the FALCON Framework can also be customized and extended with AMPLE. New commands and functions can be written in AMPLE. Routine operations can be automated by recording user actions as replayable AMPLE transcripts. AMPLE supports dynamic linking with libraries and functions written in the C programming language. Existing in-house and third-party solutions can be integrated into the FALCON Framework and access to these solutions can be provided from within AMPLE.

5. DESIGN-FOR-TEST TOOLS

A DFT tool database was developed in MS Excel. Based upon the database, Table 5-1 was generated which illustrates the gaps in currently available DFT tools in up-front test requirements and strategy management across all packaging levels (chip to system) and the holes in system and board BIT development and synthesis. Based on this gap, new tools will be developed for insertion into Baseline 2 and the final deliverable RASSP Design Environment.

Table 5-1. DFT Tool Gap.

Tool Function	System	Board/MCM	IC
Test Requirements and Metrics Management	RDD-100 with RASSP Template, Consolidated Requirements Template	RDD-100 with RASSP Template	RDD-100 with RASSP Template
Test Strategy Management	EXCEL TSD Development and TA* Definition Investigation	TSD Development - Test Means Allocation Driven by TSD	TBD Development
Test Economics Modeling	TSD Attribute Population for Predictions Under Investigation	Test Economic Services	Test Economic Services
Testability Analysis	STAT, WSTA, STARS	MGC VTM:TOP	MGC QuickGrade
BIST Insertion and Synthesis	LogicVision BIST CAD Tools	LogicVision BIST CAD Tools MGC PTM:SITE	(Synthesis) Logic Vision BIST CAD Tools, (Insertion) Synopsys Test Compiler, (Insertion) Mentor FASTSCAN
DFT/ATPG	N/A	Teradyne VICTORY, ASSET Diagnostic Systems	Synopsys Test Compiler, Mentor FASTSCAN
Fault Simulation	Tool Gap	IKOS Voyager/FS	Multiple tools available for SSF**, Delay Fault Models under development for COTS
Test Program Development	Tool Gap	ASSET, SCANease, Alternative to ASSET Teradyne Laser	Summit TDS
*TA - Test Architecture **SSF - Single Stuck-at Faults			

5.1 Process Description

The methodology begins with a tangible management commitment. This tangible commitment provides the budget and resources to proceed with the methodology.

The second step, System Definition, involves test requirements specification. The test requirements come from an integration of customer and derived requirements for the three phases of testing—design, manufacturing, and field support. Specification involves a preliminary, life-cycle cost of test analysis, a test technology assessment, and a design impact analysis to determine the reasonableness, consistency, and validity of the requirements. Subsequently, during the same step, the three sets of requirements are consolidated into a consolidated requirements specification. These activities are supported by dependency modeling using tools such as STAT and WSTA.

The Architecture Definition phase consists of three steps: functional design, architecture selection, and architecture verification. In the functional design step, the consolidated test requirements are used to develop the top level test strategy for the design, manufacturing, and field test phases.

In the architecture selection step, the top level test strategy is used to develop and evaluate various candidate, top level test architectures. The impact of each test architecture on the candidate functional architectures is assessed and incorporated into the tradeoff and selection process for them. The test requirements, test strategy, and test architecture are then allocated to BIST/DFT hardware and software for one or more of the selected architectures. The Test Strategy Diagram (TSD) is used as the primary analysis/tradeoff tool. In addition, candidate DFT and BIST techniques are identified for later implementation, based on the specified requirements. Also in this step, any top level BIST supervisory software development will begin, as will on-line BIST code, since it may have an impact on performance and throughput. Prediction and verification processes begin in this stage as appropriate for compliance tracking.

In this area, TSTB WAVEs will be used to evaluate the capabilities of candidate test equipment in measurement of required system parameters.

In the Architecture Verification step, the next level of detail of the selected test architecture(s) are generated and additional details are provided regarding the test architecture impact on the selected functional architecture(s). For example, behavioral and performance simulations will include effects of DFT/BIST techniques, such as the estimated performance degradation due to hardware concurrent fault detection circuits or due to periodic execution of on-line BIST software diagnostics. Prediction and verification processes continue during this stage for compliance tracking.

In the Detailed Design phase, test strategies, architecture, and requirements are flowed down to the detailed design of BIST/DFT hardware and software. The detailed design of the BIST/DFT hardware is performed concurrently with functional design using automatic or manual insertion and then is reflected into behavioral and structural simulation models, whenever possible. BIST insertion tools from the tool suite from Logic Vision are used to implement board level BIST. Any remaining BIST software (e.g., for power-up or other off-line BIST functions) is implemented. Test vector sets are developed and verified for each packaging level for physical prototype test, production test, and field test. All test vector sets are documented using WAVEs. Prediction, verification, and measurement processes are used in this stage for requirements compliance tracking. These properties are processed and reported by the TSD hierarchy for the project.

In the Manufacturing phase, functional and performance testing of the overall prototype is performed, with DFT and BIST hardware and software included. Tools such as ASSET implement boundary scan testing for boards which rely on JTAG test bus-based testing. VICTORY and VTM:TOP tools support this activity. Production test is performed. Verification and measurement processes are used in this stage for compliance tracking. BIST and tester-based test cost and performance data are captured and encapsulated for the reuse library. In the field phase, BIST and DFT capabilities are in use. BIST and DFT functions are also used for lower level (e.g., organizational and depot level) testing. Verification and measurement processes are used in this stage for compliance tracking. BIST and tester-based test cost and performance data are captured and encapsulated for the reuse library.

Throughout the entire DFT methodology, interfacing is done to the RASSP reuse library to access existing candidates and to add to the library when appropriate. In addition, feedback is being provided continuously from the compliance tracking process back to the responsible persons to assure corrective action is taken. Finally, it is recognized that iterations may be necessary because of the inherent nature of the RASSP methodology.

5.2 Design-For-Test CAE Tools

System Process Tools

- TSTB WAVES Test Vector generation packages from Rome Laboratory and integrated into the Mentor QuickVHDL environment are used to develop test benches in WAVES Level II format.
- WSTA by NUWC develops functional dependency models and diagnostic strategies.
- STAT by Detex Systems, Inc. develops functional dependency models and diagnostic strategies from Mentor Design Architect netlists. A translator to the Personal Atlas Workstation Software (PAWS) by TYX Corporation facilitates the incorporation of the data into Technical Requirement Documents.
- The Test Strategy Diagram (TSD) is a graphical construct which describes how flaws and faults associated with the life cycle phases of a project are handled by a set of assigned means. It is refined throughout all phases of the design cycle.

Architecture Definition Process Tools

- TSTB WAVES packages and STAT are used during the architecture definition (selection and verification) process similar to the system process as described above.
- During Architecture Selection and Verification, BIT and fault tolerant modes/functions are captured as algorithms and flowgraphs using the normal functional design tools such as SPW by Comdisco.
- During Architecture Verification BIST insertion, testability analysis and statistical fault grading tools are used as the preliminary designs are developed. TSTB WAVES is used to evaluate the capabilities of test equipment in measurement of required system parameters.
- ASIC Test Tool Suite by Logic Vision SW is used to perform preliminary test structure insertion (BIST and Boundary Scan) and to capture boundary scan descriptions of new ASICs for use in board level testability analysis tools such as VTM:TOP.

Detailed Design

- TSTB WAVES Test Vector generation packages from Rome Laboratory and integrated into the Mentor QuickVHDL environment are used to develop test benches in WAVES Level I format.
- STAT by Detex Systems, Inc. develops functional dependency models and diagnostic strategies from Mentor Design Architect netlists. A translator to the Personal Atlas Workstation Software (PAWS) by TYX Corporation facilitates the incorporation of the data into Technical Requirement Documents.
- ASICTest Tool Suite by Logic Vision SW is used to perform test structure insertion (BIST and Boundary Scan), test pattern generation, fault grading and to capture boundary scan descriptions of new ASICs for use in board level testability analysis tools such as VTM:TOP.
- VTM:TOP by Mentor Graphics is used to assess the board/MCM testability based upon boundary scan and testpoint insertion.
- VICTORY by Teradyne is used to generate boundary scan test vectors for device oriented (BICT, VCT and BFT), network-oriented test (VIT and VCCT) for virtual interconnect test of components and clusters.

- LASAR will be used in conjunction with other tools to aid in developing appropriate test vectors for functional, toggle and fault tests. Its min-max simulation capability will minimize the amount of time spent debugging test programs on testers or in target systems.
- TDS by Summit is used for conversion and enhancement of simulation test vectors into tester specific formats.
- ASSET Diagnostic System is used to develop boundary scan test programs and diagnostics. During integration and test phases, ASSET is used to control, debug and isolate problems. ASSET's Scan Function Library and ScanEngine are used to generate test programs for embedded T&M controllers which control 1149.1 resources.
- Synopsys Test Compiler combines test synthesis, ATPG, fault simulation, and test management to automate DFT.
- Mentor FASTSCAN, QuickGrade, and PTM:SITE are used for scan insertion, fault grading, and test point insertion, respectively.
- SCANease is an alternative to ASSET Diagnostic System Tools.
- STARS (formerly DARTS) from MSI Systems generates a model base for a system which provides diagnostic analysis capability and repair recommendations.
- Economic Modeling Tools from Test Economic Services present a comparison of board/ASIC costs based upon entry of board/ASIC/design details with special emphasis on ATE and BSCAN DFT.
- IKOS Voyager is proposed to be used for fault simulation.
- The Fault FS Simulation Accelerator from ZYCAD may be used.

5.2.1 Teradyne

5.2.1.1 VICTORY

Teradyne's VICTORY software fully automates test generation for boundary-scan devices in boards or modules using full or partial scan technology. For individual boundary-scan parts, VICTORY automatically generates in-circuit test patterns. For boards or modules with full networks of boundary-scan parts, VICTORY generates interconnect test patterns that provide 100% pin-level fault coverage. VICTORY also supplies tools for testing the internal logic of boundary-scan devices and for testing conventional devices or device clusters, using the scan cells connected to their inputs and outputs as virtual channels.

VICTORY generates four kinds of scan tests: boundary in-circuit tests, virtual interconnect tests, virtual component/cluster tests, and boundary functional tests. VICTORY diagnostic software helps resolve boundary-scan faults during test. VICTORY also provides Access Analyzer software to help engineers optimize boards for testability, cost, and performance before layout begins.

The boundary in-circuit tests provide automatic generation of boundary in-circuit test (BICT) patterns using information from a BSDL (Boundary Scan Description Language) model, correct analysis of device constraints like pins tied to power or ground, pins tied together, or pins without physical access, automatic detection of stuck-at pins and interconnect opens without manual probing, and automatic disabling of the boundary-scan chain during in-circuit testing.

Virtual Interconnect tests (VIT) provide automatic generation of test patterns for 100% pin-level fault coverage, automatic detection and diagnosis of stuck-at pin faults and shorts and opens between boundary-scan parts without manual probing, automatic detection of shorts between

boundary-scan nets and conventional logic nets that have bed-of-nails access, and automatic conversion of parallel patterns into serial, tester-compatible format with comments for simplified debugging.

Virtual component/cluster tests (VCCT) provide virtual bed-of-nails controllability and observability for testing non-scan circuitry without physical access, automatic serialization of parallel test patterns for testing individual non-scan devices or clusters of non-scan devices via the boundary-scan path, automatic organization of bit-level data for synchronous application via a combination of real and virtual channels, and simplified circuit initialization by direct forcing of inputs to desired states.

Boundary functional tests (BFT) provide thorough testing of the test access port (TAP) and 1149.1 registers, automatic testing of core device logic through the TAP using the new Serial Vector Format (SVF) interchange standard, compatibility with test techniques such as INTEST, BIST, and internal scan, made available by the device designer, and dynamic testing of device performance by applying built-in-self-test (BIST) instructions via the scan chain where the system clock is used.

5.2.1.2 LASAR

LASAR by Teradyne is used to perform min-max simulation to uncover timing problems with test vectors and to develop test programs and diagnostics for board and MCM tests on ATE such as the Teradyne L300 series. LASAR is the only tool within the Design Environment which supports min-max simulation to perform accurate simulation of circuit logic, signal timing including race conditions and performance faults. Due to this accurate simulation, LASAR can be used to predict how the Unit Under Test (UUT, i.e., board/MCM) behaves during test. Time spent developing and debugging test programs on expensive testers is reduced significantly or eliminated.

5.2.2 Naval Undersea Warfare Center

5.2.2.1 WSTA (Weapon System Testability Analyzer)

As a generic element of the IDSS (Integrated Diagnostic Support System) the WSTA provides a comprehensive engineering design and maintenance support tool for improving the effectiveness and testability of new and existing systems, both electronic and non-electronic. The WSTA can be used to interact with a system throughout each phase of design, development, and deployment to ensure an optimal design for testability. Figure 5.2-1 depicts the WSTA within the IDSS process.

The WSTA makes use of a Standard System Model (SSM) representation of the system under consideration. A valid SSM will accurately reflect the failure mode dependencies/dependency model (DM) of the system components. The WSTA user must perform the proper system analysis to derive a DM which is reflective of the defined failure modes for the particular system under consideration. Once the user has an acceptable DM he can proceed to input the model into WSTA. This can be done manually via keyboard entry.

In order to save manual entry time, the user may choose to import circuit descriptive data via Computer-Aided Engineering (CAE)/Computer-Aided Design (CAD) and Logistics Support Analysis (LSA) files. The model generated will contain structural, relational and statistical information about the system design., The CAE/CAD approach will allow WSTA to generate a working SSM to which the dependency model data can be applied using the WSTA Model Editor. The structural portion of the CAE/CAD model may be derived automatically from the Very High Speed Integrated Circuit (VHSIC) Hardware Description Language (VHDL) representation of the system. Statistical/parametric information (i.e., test costs, component replacement costs, Mean Time Between Failure (MTBF), etc.) in the form of a LSA data file is merged with the CAE data into a WSTA Input Data Base (WIDB). Figure 5.2-2 illustrates the WSTA functions and process flow with the CAE/CAD derived data base (WIDB) shown as an optional starting block.

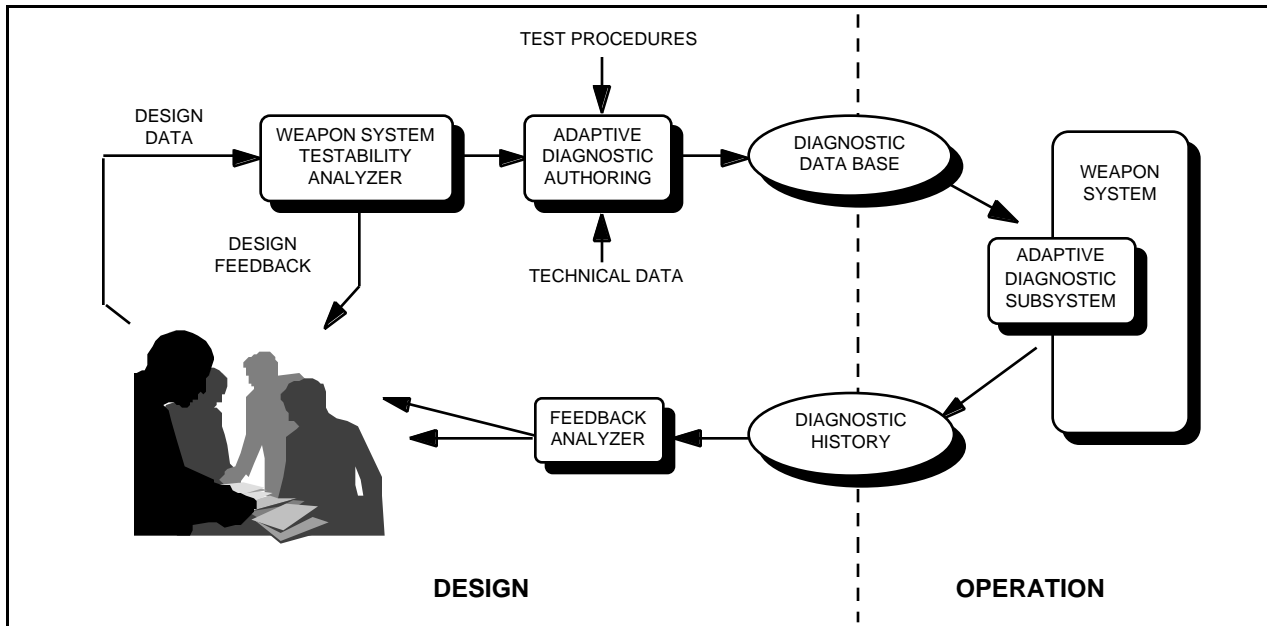

Figure 5.2-1. WSTA role in IDSS.

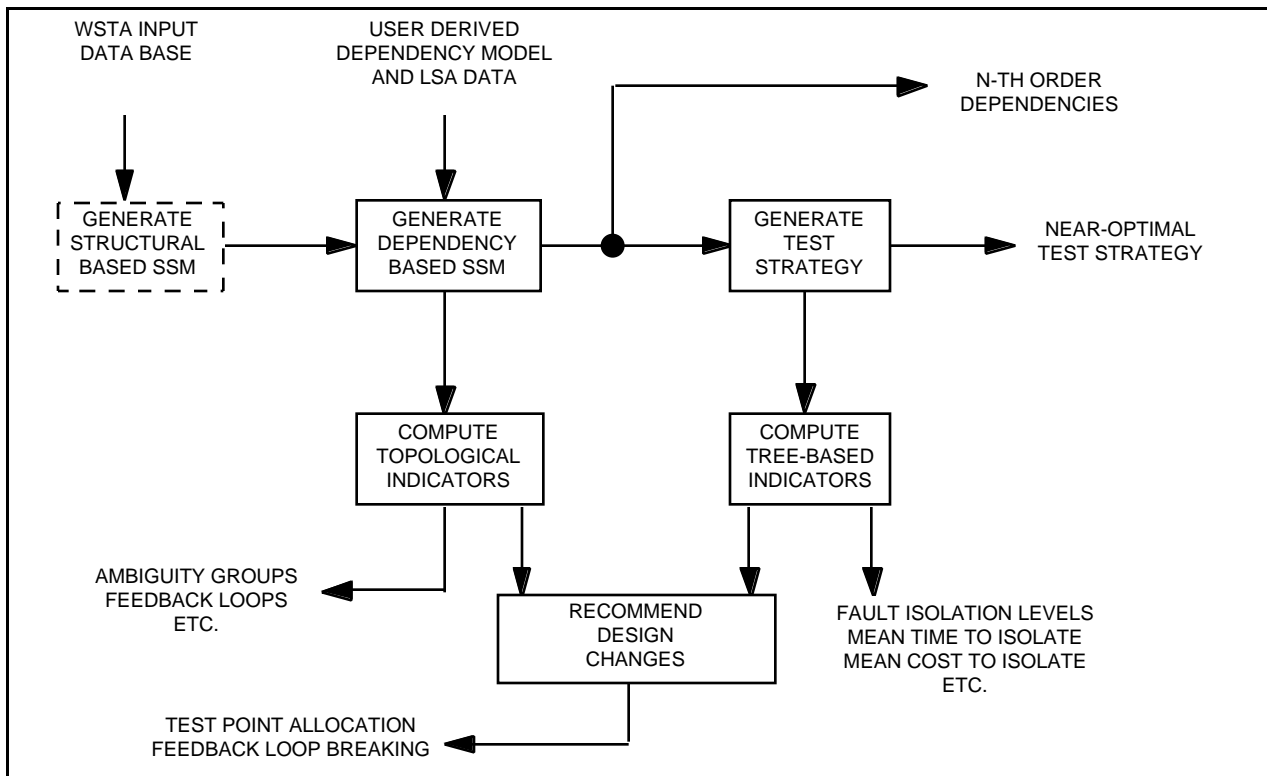

Figure 5.2-2. WSTA functional flow diagram.

Dependency modeling as used by the WSTA, by its very nature, is a general technique for representing any type or level of the system design including electrical, mechanical, hydraulic, or any combination thereof.

Using the SSM as the foundation, the WSTA performs four classes or types of analyses: 1) static analysis, 2) test strategy generation, 3) dynamic analysis, and 4) DFT advisement.

Static Analysis

Using information about the system design contained within the dependency model, the WSTA Static Analyzer generates Testability Figure of Merits (TFOMs), which are measures of the inherent fault isolation characteristics of the design. The static TFOMs include information as follows:

Ambiguity Group Distribution Data - This information is a tabulation of ambiguity group composition, sizes, and aggregate failure probability.

Inherent Fault Isolation Levels - This is the traditional "scoring" factor commonly expressed as isolation to "X" number of components "Y" percent of the time.

Component Involvement Ratios - This data is a measure of the relative frequency with which each component appears in any ambiguity group.

Feedback Loop Data - This is a tabulation of feedback loop compositions, sizes, and aggregate failure probability.

Alternate Control/Observation Point Data - This information is a tabulation of alternate places in terms of input and output tests (upstream/downstream) where a given test result may be controlled or observed.

Test Strategy Generation

To determine the testability of the Item Under Test (IUT) based upon real world conditions, the WSTA Test Strategy Generator creates a diagnostic fault tree (i.e., a test strategy). The test strategy is an optimal (in terms of minimization of the expected value, averaged over all possible failures, of a linear combination of test time, test cost, risk, a user definable test related parameter, and number of tests) or near-optimal sequence of diagnostic tests for isolating each and every failure mode (aspect) of each and every component in the SSM. The test strategy is based on the assumption that a single aspect of a component described by the SSM is faulty. The test strategy fault tree represents a "dynamic model" of an on-line fault isolation scenario. The test strategy fault trees are ultimately stored within the Diagnostic Data Base (DDB) and may be later used by the IDSS Adaptive Diagnostic Subsystem (ADS), or similar diagnostic aid to assist in the fault isolation process.

The test strategy takes the form of a pass-fail decision tree. That is, at each node in the tree a list of suspect failure modes (or aspects) exists, and a test is identified to be performed that will best split the suspect failure modes depending on the test pass or failure criteria. Two new failure mode lists are generated; one list of suspect failure modes for the pass leg and one list of suspect failure modes for the fail leg. Processing continues to build the test strategy by determining the "next best test" recommendation for the failure modes listed until the lowest levels of the tree are reached. The lowest levels are the leaf nodes representing identification of the failure mode (single fault component) or the lowest level ambiguity group. The technique of selecting the "next best test" defines how the test strategy is optimized. An artificial intelligence heuristic state space search technique is employed that generates an optimal or near-optimal fault isolation test strategy. The heuristic employed is the "INFO-GAIN" heuristic.

Dynamic Analysis

The WSTA Dynamic Analyzer uses the "Dynamic Model" (test strategy) to compute and predict additional TFOMs indicative of the model of the system, and thus, if the model is accurate, the system design. These indicators represent the testability performance that may be expected during an actual, on-line fault diagnosis session and include the following:

Isolation Penalties - Mean Time to Repair (MTTR) based on individual isolation times calculated automatically from the logistics data stored in the Common Diagnostic Data Base (CDDB),

coupled with individual component replacement times, and similarly, Mean Cost to Repair (MCTR).

Replacement/Isolation Tradeoff Data - Provides the user with visibility into the overall testing picture for the IUT. For example, sometimes it may be cheaper to stop testing with a somewhat larger than ideal ambiguity group than to incur the increased expense of additional testing. This data is computed for each node in the Test Strategy Fault Tree and will help the user make that determination.

Test Point Utilization Data - Provides a measure of how often each ambiguity group appears in a given test strategy. This information is also useful for making recommendations to improve the overall testability of the IUT when selecting test points and incorporating Built-In-Test (BIT).

Test Point Criticality - Provides a measure of the criticality of a test point by providing the aggregate criticality of the components associated with a given test point in the context of the test strategy. That is, the test point criticality is the number of critical components the given test point may be used to isolate and is a relative figure of merit as to the importance of the point. Test points with low criticalities that are removed have less impact on mission success since their removal results in a lower rate of growth of ambiguity group size than removal of high criticality test points would yield.

Design for Testability Advisement

Once the testability of the IUT has been assessed, the user is presented with at least two options to follow. The first, and ideal case, is that the IUT meets each and every one of the testability requirements that have been imposed on it. In this ideal case no further analysis is required, and the job of the user is complete. In the more common case, however, the user is presented with a different situation. The IUT has failed to meet its testability requirements, and the user is responsible for making changes or recommendations for improving the IUT's testability performance. The DFT Advisor analyzes the static and dynamic testability indicators and provides the user with a set of recommendations for improving the testability of the IUT. The recommendations provided are the following:

Loop-Breaking Recommendations - The optimal point to break each feedback loop, including an ordered list of alternatives, is provided for each feedback loop in the model.

Test/Test Point Built-In Test (BIT) Recommendations - Based upon the test strategy, the WSTA will recommend a set of BIT tests/test points required to certify an IUT as being operational.

Test/Test Point Deletion Recommendations - Based upon tests in the test strategy, (i.e., tests that provide no additional information) coupled with structural information from the model, the WSTA will provide a list of tests/test points which are redundant (i.e., tests that provide no additional information in the fault isolation process) in the current design.

Test/Test Point Addition Recommendations - Using information provided by the user concerning which nodes in the IUT should be considered as test points and which ones have not been selected, the WSTA provides a list of those nodes that, if made into test points allowing for corresponding new tests, will provide the overall testability of the IUT.

To support the above functions, the WSTA contains utility functions to provide access to the data stored in the DDB, interface services for ease of selecting available functions from menus, a comprehensive model editor for the modification or creation of system and model data, and report generation facilities to enable the user to obtain displays for hard copies of the data and recommendations.

5.2.3 Detex Systems, Inc.

5.2.3.1 STAT (System Testability Analysis Tool)

STAT is a Functional Dependency Modeling computer software which allows the automatic development of consistent and correct diagnostic information from either a top-down or bottom-up systems approach describing "How the design Works". STAT may be used to maximize the diagnostic benefit with existing designs, or with contemporaneously with the concept and proposal phases of new designs for concurrent engineering implementation. When applied to hardware data bases it:

1. Determines Ambiguity (Fault) Group sizes and the percentage of time one can expect to experience a fault in each Group.
2. Suggests BIT/BITE placement.
3. Defines feedback loops and recommends the most efficient control (break) points.
4. Develops a Diagnostic Flow Diagram and Table with backup detailing the controllability and observability associated with each isolated malfunction.
5. Develops an accurate and concise list of hardware associated with the failure of any particular test or combination of tests.

There are many kinds of equipment, and many types of malfunctions. And, in hybrid designs there are even more combinations of events which may cause a malfunction. The sense of coverage which STAT reports on is absolute in that it assumes that ANYTHING can be the cause of a malfunction and goes about deriving the smallest non-ambiguous grouping of parts to which the test technician can isolate. STAT concentrates on the operational aspects of a piece of hardware and whether ALL operational aspects have been covered (how else will anyone know that he has a malfunction but that one of the operational characteristics was not present).

Some of the quantitative measures that STAT reports on are:

Mean Time to Isolate Malfunctions - Using available incremental test times, the STAT Software will generate this measure in accordance with paragraph 1.3.2 of MIL-STD-472 (Maintainability Prediction).

BIT/BITE Recommendations - On the basis of the proven diagnostic strategy contained within STAT these recommendations will represent the most required test nodes for fault isolation.

Feedback Loop Disclosure - Control of Feedback Loops can play an important part in the minimization of Ambiguity Group sizes. Therefore, it is important that specific information about these loops be disclosed.

Recommended Soft and Hard Break Points - A unique algorithm in STAT provides the most logical break point(s) along with comparative ambiguity group results if other break points are chosen.

Controllability and Observability Points - These points are made on the basis of all interdependent functional and hardware knowledge possessed by STAT.

Fault Detection Determination - Here STAT suggests what the Output Testing Order should be to provide 100% detection of Malfunctions with as few tests as possible. STAT also allows the User to determine his own Output Ordering Sequence to obtain the percentage of Detection that can be achieved, within a specific number of tests. This is not a calculation, but rather REAL information that can be enforced in the maintenance shop TODAY.

Diagnostic Flow Table and Diagram - This information is displayed in a WYSIWYG Viewing window with special "Hot Scrolling" Features. In instances where schematic detail is input to the STAT Software, this information is directly usable at the user's facility to isolate actual malfunctions in any maintenance document like a T.O., TRD, or TPS.

STAT is a mature method of creating, structuring, and organizing a complete database (model) of any design to formulate and expose proven objective, consistent, and accurate testability and diagnostic information. STAT is directly related to the Dependency Modeling required by MIL-M-24100 (as a referenced specification to MIL-STD-1388). Its Functional Dependency Model database can be used to produce either inherent or dynamic diagnostic data for the instantaneous creation and implementation of a powerful, customized "Diagnostic Strategy Engine". It can objectively and consistently produce Testability Reports (which categorize both Test and Testability parameters), Diagnostics directly applicable to Portable Maintenance Aids, Production Testing, and Automatic Test Program Sets (Development/Modification). It can also be used to influence and enhance LSA and FMEA information.

The STAT database is uniquely capable of exposing any logical errors through the use of ancillary functional block diagram creation and test prompting tools (DIAGRAF and DIAVIEW). It can be automatically and concurrently created with the design (via CAD import capabilities) and provide an accurate and objective feedback and assessment of the design to all Concurrent Engineering (or Integrated Product Development) disciplines (including Design, Support, Production, Value Engineering, Contracts, etc.). Thus, by definition, DYNAMIC INTEGRATED DIAGNOSTICS is an easily accomplished process.

STAT, uniquely and instantaneously determines i-th order dependency relationships of all design elements and therefore, can determine simultaneous multiple malfunctions and can provide an indefinite number of diagnostic scenarios based on many differing maintenance concepts. Since STAT is System oriented, it allows the collection of Libraries of information to be easily linked. Because of the System aspects of STAT, it is able to easily be manipulated as desired by the Customer. Therefore, STAT is able to retain the integrity of the design at a macro-perspective of the system, while retaining the refinement of the design to its smallest component part or signal related thereto. Likewise, detectability and fault isolation can be performed at an level, while having the flexibility to adjust in accordance with any restrictions or conditions that may be assessed on the diagnostic process.

The direct outputs of STAT can be used to satisfy the requirements of MIL-STD-2165 (Testability), MIL-STD-1345 (Test Requirements Documents), and MIL-STD-1814 (Integrated Diagnostics).

5.2.4 Logic Vision Software

5.2.4.1 ASIC Test Tool Suite

ASICTEST

ASICTEST is a family of test automation products that reduce time-to-market while implementing a high quality and low cost test strategy. It couples front-end generation of synthesizable RTL code for memory BIST and 1149.1 TAP/boundary scan, with back-end tools for scan insertion and combinational ATPG. ASICTEST features three products: ICRAMBIST, JTAGSYN, ICSCANTEST. Together, they provide a complete test strategy for complex, structured custom ASICs.

Figure 5.2-3 shows the interrelationships among these tools in the context of design stage. Front-end phase corresponds to logic generation. Back-end refers to test of logic which has been generated during the front end processing.

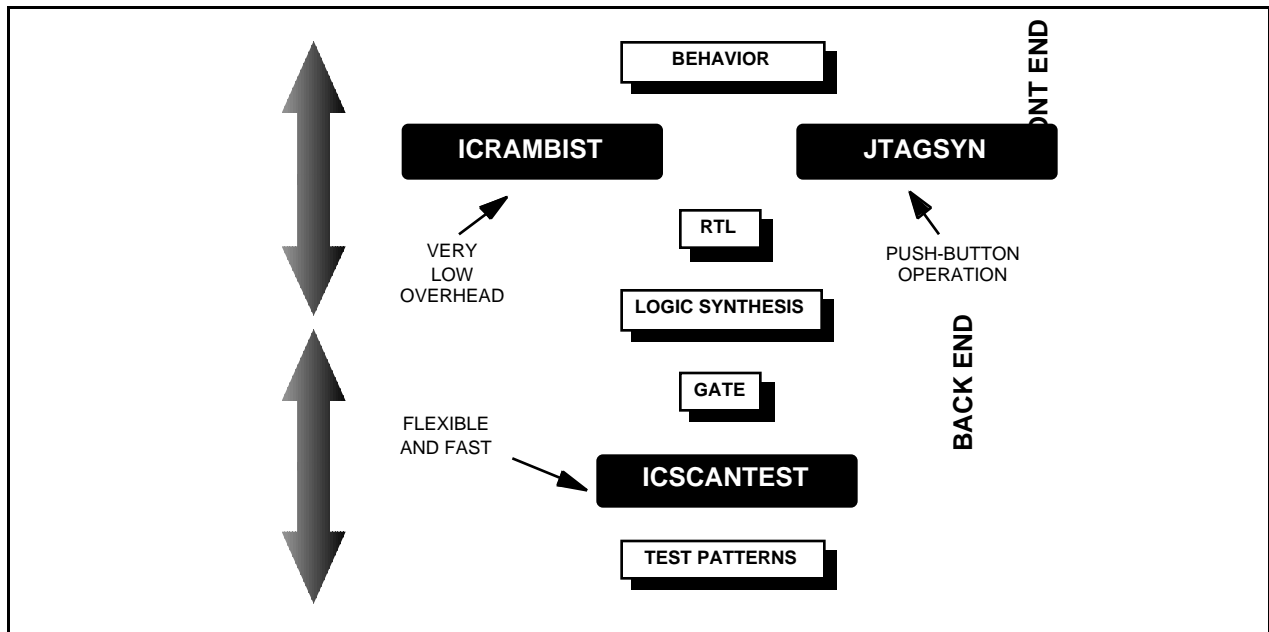

Figure 5.2-3. ASICTEST tool suite.

ICRAMBIST

ICRAMBIST is a front-end test automation tool that is run early in the design flow to generate a complete design implementing BIST of embedded static RAMs. The tool generates synthesizable RTL code (plus constraints) for a BIST controller and any memory interfaces needed to implement an efficient, deterministic BIST scheme for the memories. To validate the design, a stimulus file is generated for use with simulation.

ICRAMBIST implements a patented memory BIST strategy that offers at-speed, deterministic testing of the memory, with low area overhead and low routing complexity. The BIST controller generated by ICRAMBIST contains a finite state machine that implements standard memory testing algorithms. Unlike a random pattern scheme, the ICRAMBIST scheme gives known fault coverage. A BIST collar is generated for each embedded memory permitting the BIST controller to apply the test patterns through a serial data path. The collar loads and unloads the memory data in parallel and at-speed. The scheme also allows multiple memories, of variable size, to share the same controller.

The use of a serial data path and the ability to share a controller among multiple memories makes the overhead extremely low. The area of a BIST controller or a collar is only about 400 gates each for a MARCH test and varies little with memory size. The collar introduces a single mux delay on the memory signals, but in many technologies this mux is now included in the memory.

The overhead introduced by using the BIST scheme is more than offset by the savings in test pattern development effort. Using BIST eliminates the need to develop any memory test patterns. The test pattern simply turns on the controller and monitors the BIST status bit.

JTAGSYN

JTAGSYN is a front-end test automation solution that is run early in the design flow to generate a complete set of design files to implement 1149.1 Test Access Port and Boundary Scan. The tool generates synthesizable RTL code for the Test Access Port (TAP) and Boundary Scan cells. It also provides a complete top-level module instantiating and connecting the TAP and BSCAN cells together with the I/O pins and the core modules. To validate the design, a stimulus file is generated for use with simulation. In addition, JTAGSYN produces a Boundary Scan Design

Language (BSDL) file that can be used to describe the ASIC to board-level test tools. A vendor pinout file for the ASIC is also generated.

JTAGSYN works from a technology independent, pin description file. Describe the pins needed for the ASIC, and the desired options, and JTAGSYN is ready to run. Changes to the top-level module can be made quickly, simply by altering the I/O description and regenerating.

The TAP and Boundary Scan cells generated by JTAGSYN are based on a customizable library allowing different 1149.1 implementations. The product comes with a library featuring a flexible TAP, with optional device ID register, and a complete set of Boundary S cells. The TAP offers an extended instruction/status register for supporting internal scan, BIST and other user test modes. The Boundary Scan cells in the library include input, output, bi-directional, enable and sample-only capabilities.

JTAGSYN does not require the designer to be an expert in the 1149.1 specification or create and edit a BSDL file. The input is a text file in which the designer only specifies design information, such as the pin list, special core nets (clocks, reset, scan, and status), and any options. JTAGSYN accepts these inputs and performs processing necessary for boundary scan logic generation.

ICSCANTEST

ICSCANTEST is a full suite of tools (ICSCAN™, ICCHECK™, ICATPG™, and ICREORDER™) for scan chain insertion, scan rule checking, combinational ATPG and fault simulation, and test pattern ordering/formatting/verification for gate level netlists. Flexibility is in the form of user options and support for scan models. The scan models permit the tools to transparently handle memories and test mode logic (like the 1149.1 Test Access Port), as well as some nonscannable circuitry.

ICSCAN offers flexible scan chain insertion to enhance the testability of the gate level netlist. The tool automatically replaces regular flip-flops with scannable equivalents and then routes the scan chains between them. The designer can specify which flip-flops or modules should be scan inserted, the number of scan chains and the preferred routing order. Existing scan chains can be specified and connected. The modified gate level netlist can be fed back to logic synthesis for re-optimization.

ICCHECK verifies that the circuit meets standard scan design rules and extracts the combinational portion of the circuit while taking into account the scan models. The rules are applied in test mode only, thus clocking strategies in normal system mode can be more flexible.

ICATPG automatically generates test patterns for the combinational portion using both deterministic and pseudo-random approaches. It has very high performance and is capable of handling circuits with hundreds of thousands of gates using both stuck-at faults and transition faults. It also supports incremental fault simulation and pattern generation for target fault lists.

ICREORDER sequences the test patterns for application to the scan chains from the external pins. It understands 1149.1 and generates the test set taking it into account. The final test set may be targeted to a number of different simulation, tester and vendor formats.

5.2.5 Lockheed Martin ATL/Self Test Services

5.2.5.1 Test Strategy Diagram

TSD Concept

The Test Strategy Diagram is a graphical construct which describes how flaws and faults associated with the life cycle phases of a project are handled by a set of assigned means. The fault coverage effectiveness of each means in terms of detection, isolation, and correction and the

order in which the means are applied are specified. Figure 5.2-4 shows the elements of a TSD. The processes of detection, isolation, and correction by each of the assigned test means are described in three rows of elements containing transfer functions and attributes. The transfer function represents the effectiveness of a test means at either detection, isolation, or correction. Each successful detection, for example, is passed on to the same test means for isolation. If possible, isolation is accomplished and is passed to that test means for correction. An unsuccessful attempt at detection, isolation or correction is immediately passed on to the next test means for possible resolution. Successful operations are indicated by the paths labeled Os, which represents the number of events successfully processed by the test means at that particular stage. Unsuccessful operations are indicated by Ou, which is the number of missed detections, isolations, or corrections. Effectiveness of a test means at any operation is quantifiable as the ratio of the Os value to the number of incoming faults. This ratio is called the transfer function for a specific test means for a specific operation. These are indicated as TFDi in Figure 5.2-4. Other entries a TSD are the test attributes labeled ATTR in the boxes. These typically are cost and time for each particular test for each operation. Other significant quantities can be added to reflect a specific test environment.

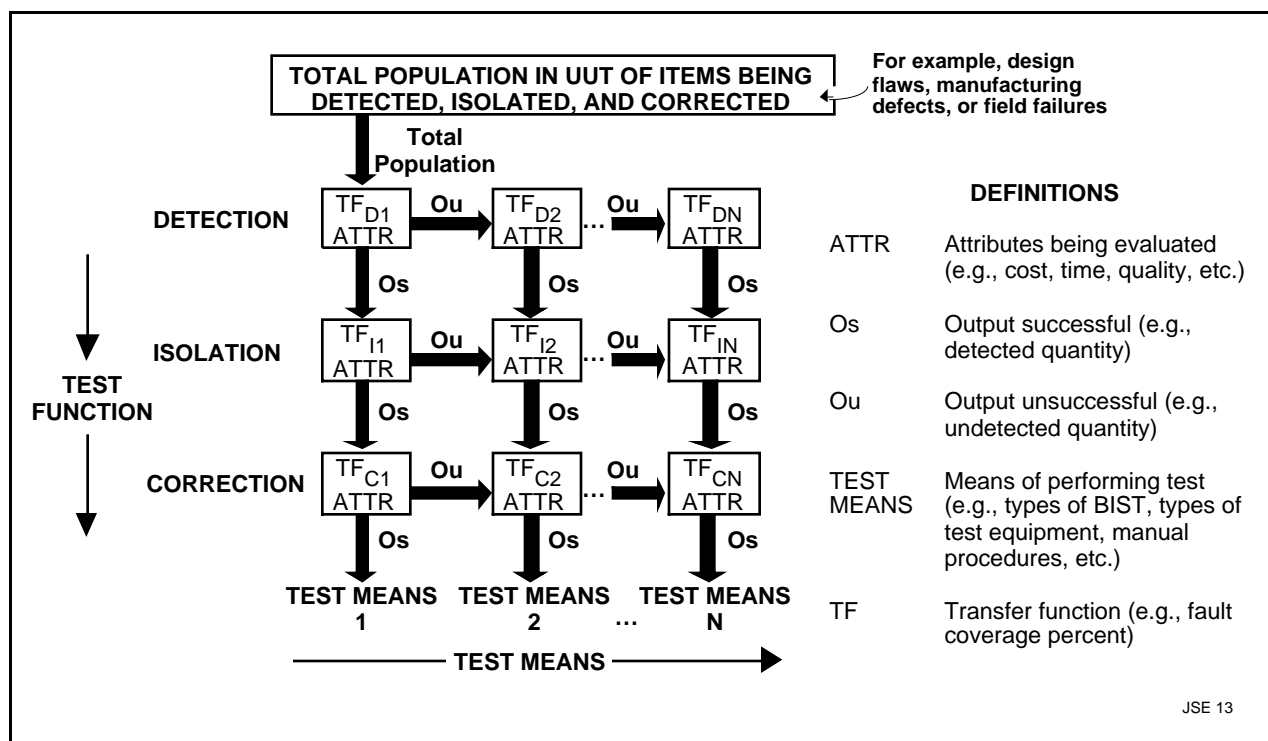

Figure 5.2-4. Test strategy diagram concept.

The TSD is constructed from the test means information specified in the Consolidated Requirements document. It summarizes the results of the process of converting project requirements to test means sequences with assigned flaw/fault coverage performance. More specifically, it displays the singular test philosophy and any supplemental test means added to a particular project phase. It becomes the vehicle for quantitative measurement of conformance to requirements based upon application of the selected test means. The TSD explicitly shows the effects of application of each of the test means selected for each phase of the project life cycle. A TSD for a project phase such as manufacturing is made by creating a three row by N column matrix containing detection, isolation, and correction entries in the rows and N test means in the N columns. The test means are ordered as specified in the final version of the consolidated requirements template sheets for the manufacturing phase.

There is one TSD for each of the identified flaws/faults associated with the design, manufacturing, and field support phases of a project.

The complete collection of TSDs consists of a hierarchy of matrices which spans project phase and packaging levels as shown in Figure 5.2-5.

Four classes of TSDs exist:

1. Requirements TSDs which specify the requirements allocation to the available test means, i.e., what is expected from each test means toward satisfaction of a given test requirement.
2. Prediction TSDs which specify expected test performance during system planing and early design phases based on historical engineering experience.
3. Verification TSDs which are populated with the results of simulations of tests.
4. Measurement TSDs which are populated with the results of actual measurements of test effectiveness.

The classes are represented by the labels R, P, V, and M in Figure 5.2-5.

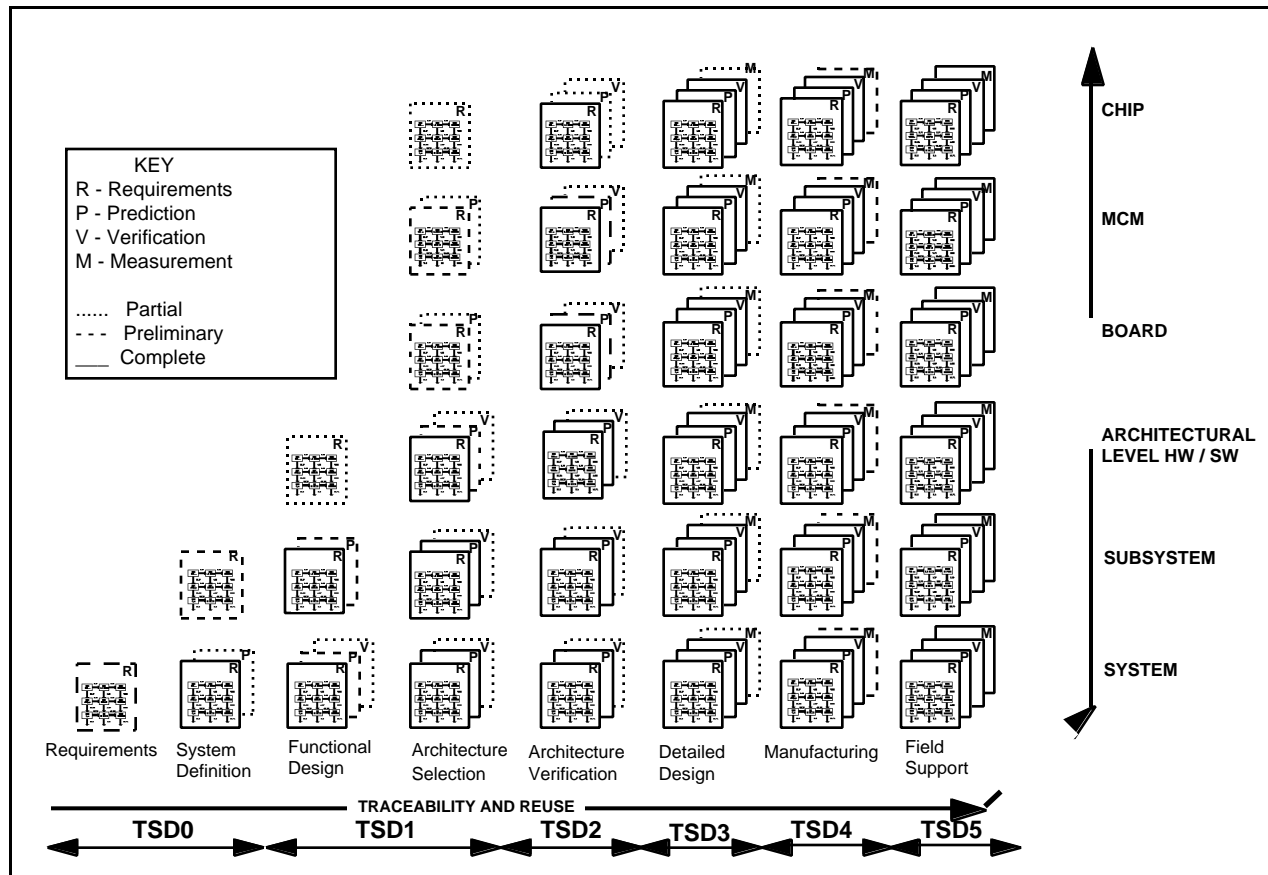

Figure 5.2-5. Hierarchy of test strategy diagrams.

All TSDs related to a particular flaw or fault have the same form regardless of class. The purpose of multiple classes is to allow for comparison among the classes. This enables constant comparison of test means performance at any phase and packaging level of a project with requirements assigned to that test means. A secondary purpose of multiple TSD classes is validation of assumptions made at system design and verification times.

TSD Implementations

The TSD sets for BM3 were constructed as EXCEL workbooks. A workbook is essentially a three dimensional “spreadsheet”, a collection of related two dimensional spreadsheets designed to efficiently implement data sharing among all the two dimensional spreadsheets in the set. These worksheets will be referred to as Sheets in the following discussion.

Each workbook consists of a set of worksheets which details the four classes of TSDs for one particular flaw or fault. Three worksheets form a set capable of controlling/monitoring handling of a specific flaw/fault. A separate workbook is assigned to each flaw and fault for which requirements have been established. Individual worksheets are assigned to requirements, predictions, verification, and measurement related to the flaw/fault. For any one complete workbook, the number of worksheets will be up to 12. At system design levels, fewer Sheets will be needed since verifications and/or measurements may not apply. Twelve sheets will be required at the field support project phase and at the manufacturing phase for handling acceptance/qualification testing.

During the system concept and design development phases of a project, the requirements and prediction worksheets are populated. The verification and measurement worksheets will be populated as the project proceeds into the actual design and fabrication phases.

Figure 5.2-6 shows a typical EXCEL TSD describing requirement allocations to selected test means for bridging, open, and stuck-at faults which characteristically occur during a project manufacturing phase.

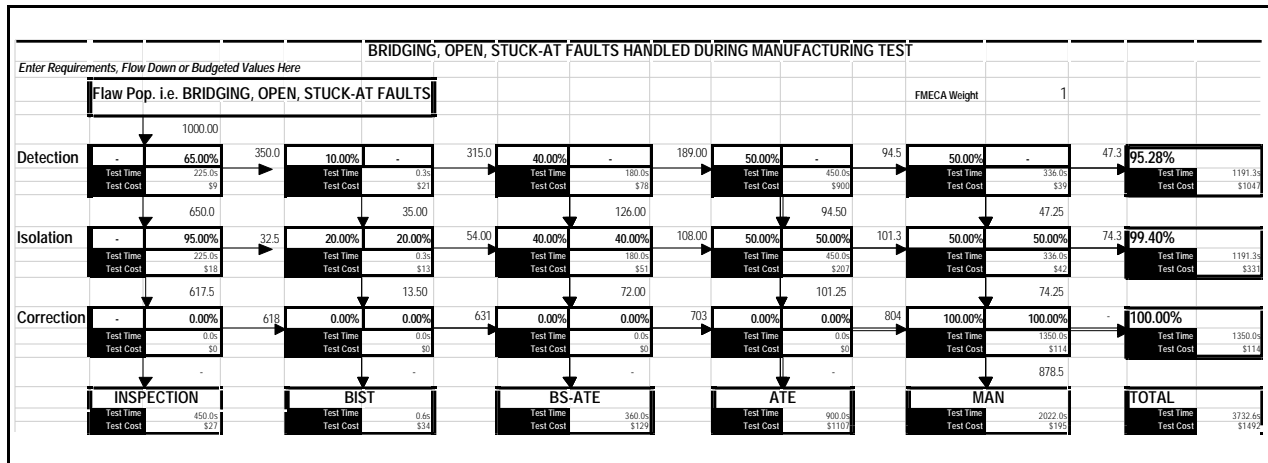

Figure 5.2-6. Typical requirements TSD.

This TSD describes details of the allocations to the detection, isolation, and correction levels which are required to be achieved by each of the test means assigned to the testing for the flaw/fault. On this sheet, the user will enter the transfer functions, cost, and time allocations appropriate to the flaw/fault being processed.

5.2.6 ASSET, Inc.

5.2.6.1 ASSET Diagnostic System

The ASSET Diagnostic System supports interactive debug and test of IEEE 1149.1-component designs. This bus supports controllability and observability of components and interconnections on a printed circuit board (PCB) via a 4 wire connection to the PCB. Components are serially linked in a scan chain. Serial test vectors can be applied to components to drive them as required. Also, the state of the output pins on components can be obtained via serial read process. The Diagnostic System allows a user to interactively control and observe scannable signals at the register, bus, or pin level. The Diagnostic System also provides the capability to

locate faults found on a device, board, or system. These faults can be detected through interactive access and control and scan vector analysis.

The ASSET Diagnostic System uses standard JTAG instructions such as EXTEST to debug designs interactively. The Diagnostic System has features similar to logic analyzers to aid the hardware engineer doing prototype design verification in an R&D lab.

The ASSET Diagnostic System includes all capabilities found in the ASSET Test Vector Development System. These include:

- ASSET data base creation and maintenance.
- Serial vector input, output, and analysis.
- Parallel vector serialization.
- Automatic assembly diagnostics.
- Easy vector development through the ASSET macro language.
- Scan path integrity checking with Scan Path ATPG.
- ASSET scan hardware for interaction with your unit under test (UUT).

In addition, the Diagnostic System includes the ASSET Scan Analyzer™ and Debugger for interactive access, control, and observation of a UUT.

Scan analyzer is used to view vectors and analyze response of hardware by comparing expected and actual values.

The ASSET Debugger provides controllability and observability of the IEEE 1149.1 architecture with the following features:

- Graphical view of the design hierarchy.
- Ability to edit scan data at the register and pin level.
- Data manipulation via user-defined symbolics or via binary, decimal, or hexadecimal data input.
- Register grouping based on a design's functionality.
- One-button interface to apply changes made to instructions and data values.
- Single-step application of pre-existing macros or serial vectors.

The ASSET system installs on a PC and interfaces to a board under test via a standard JTAG test bus link.

5.2.7 Mentor/Teradyne

5.2.7.1 Virtual Test Manager: Testpoint Optimizer Software (VTM:TOP)

VTM:TOP is a VICTORY™ software developed by both Mentor and Teradyne. It enables design and test engineers to take maximum advantage of the observability and controllability provided by boundary-scan devices on electronic assemblies that have a mix of boundary-scan and conventional technologies.

VTM:TOP provides the engineer with a link between design and test. It provides optimized test-pad selection for PCBs and MCMs that contain boundary-scan (IEEE 1149.1) devices. VTM:TOP is used after design entry and before CAD layout, to generate reports that help selection of the optimum number of test pads for both in-circuit and functional cluster testing.

When VTM:TOP is used along with Mentor's Physical Test Manager, testpoint analysis and placement is fully automated. To allow performance of testpoint analysis as part of the design trade-offs, VTM:TOP is integrated with DSS, Design Viewpoint Editor, and Board Station.

Testpoint analysis includes:

- Pre-layout analysis of board-level testability issues.
- Automatic review of scan and non-scan networks for controllability and observability.
- Automatic identification of full boundary-scan networks providing 100% controllability and observability without bed-of-nails access.
- Automatic ranking of non-scan devices based on where a minimum amount of test points can be added to achieve the maximum amount of testable devices.

VTM:TOP can specify the networks that do not require access when using the VIT technique. Conversely, it can recommend networks that should have access to minimize complexity when using the VCCT technique.

5.2.8 Rome Laboratory

5.2.8.1 TSTB WAVES

TSTB is one of the prototype WAVES tools developed by Rome Laboratory. The WAVES objectives are to capture logic signal histories during simulation or UUT test patterns during hardware test and easily exchange data between them. When TSTB is run on a VHDL design, the WAVES model specific packages generated are the UUT_pins package, the waveform generator procedure template, and the header file template and the test bench. The waveform generator file is then modified to describe the input/output waveforms and the clock period. The test bench generated by the tool wires the WAVES waveform data set and the VHDL model together for design verification. A user developed vector file to stimulate the testbench is needed to stimulate the program. This vector file is very similar to the one which will ultimately be used for hardware test.

5.2.9 Summit

5.2.9.1 TDS (Test Development Series)

The TDS software system is designed to provide all the tools needed to manage the behavioral data associated with an electronic product development cycle. With TDS, data is generated, reformatted, stored, analyzed, modified, and transformed into test programs to support all phases of design and production.

Data can be used from many sources. Data from most simulators can be processed and existing test programs can be used as a data source. Data can be viewed with the TDS tools and then quickly analyzed for completeness and adherence to specifications. In addition, the capability to check data compatibility with the intended tester.

Modifications of the waveforms including adding or adjusting timing information, aligning signal edges, eliminating unnecessary pulses, and eliminating hazardous test conditions can be accomplished. Output can be generated for resimulation or for production of high quality test programs for the tester of choice.

The TDS software system consists of many modules. The components of the TDS software system are:

- ASCII I/O Interface - inputs and outputs waveform data in a standard format for the user's proprietary tools.
- Conditioners - modify SEF (Standard Event Format - one of Summit's internal databases) to solve tester compatibility problems or to add device specification information.
- In Converters - accept simulation data and reformat it into waveforms in the SEF database.
- Out Converters - output waveform data as simulation force files for resimulation.
- Test Program Emulators - generate waveform data from existing test programs.
- Test Program Generators (WaveBridge) - output test programs generated from timing and waveform data from separate sources.
- Simulation Rules Checker - analyzes waveform data for compliance to user-specified rules.
- Utilities - permit the display, printing and analysis of waveform data from the SEF.
- SEF Database - holds the behavior information as unstructured events (wave data without timing).
- Waveform Database - holds the behavior information as structured events (wave and timing data).
- WaveMaker - provides graphical editors to modify WDBs (another Summit data format) and allows creation of graphical job flow scenarios that use other TDS modules.

5.2.10 Mentor

5.2.10.1 FASTSCAN

FASTSCAN replaces flip-flops in the design with scan flip-flops and generates test vectors.

5.2.10.2 QuickGrade

QuickGrade is used for fault grading.

5.2.10.3 PTM:SITE

PTM:SITE inserts test points on MCM Station using results from VICTORY.

5.2.11 National Semiconductor

5.2.11.1 SCANease

SCANease is an alternative to ASSET Diagnostic System tools.

5.2.12 Synopsys

5.2.12.1 Test Compiler

Test Compiler combines test synthesis, ATPG, fault simulation, and test management to automate DFT. Test Compiler products are used throughout the design process to analyze and improve the testability of designs. Test Compiler family products can be used to synthesize and

insert test structures into the design and generate high fault coverage test patterns for scan-based designs.

5.2.13 MSI Systems

5.2.13.1 STARS (Formerly DARTS)

STARS produces a design model-base directly from Computer-Aided Design (CAD) output data files. The STARS architecture includes automatic translation of CAD output in either EDIF or VHDL format. Most popular CAD systems today output EDIF format. In the future, VHDL design representation will become the standard for DoD design efforts. In cases where no CAD data exists, the STARS has been supplemented with a commercially available, off-the-shelf, low-cost schematic design tool, OrCAD, which can be used to graphically enter schematic data and then output into the appropriate EDIF format.

As the design of a system evolves, it is necessary to generate a series of diagnostic design candidates in order to support the trade-off and optimization process. Without the ability to have multiple candidates, the systems engineering team does not have the detailed insight required to make informed decisions. A diagnostic design candidate is a profile of the diagnostic capability and accuracy given a specific combination of tests: performance monitoring, built-in tests, operator observations, external tests and measurements, and probe points.

STARS has automatic utilities for incorporating design updates into the model-base. The utilities serve to “merge” the updated design into the old design, including all associated diagnostic design candidates. The only manual part of the process is in defining the attributes of the updates. STARS assists the user in this task by pinpointing where the design has changed. The use of X-Windows under DESQview/X enables the testability interaction to occur directly on the designers CAD platform (PC or workstation).

STARS employs a dynamic reasoning capability called a Diagnostician. A Diagnostician is the combination of the model-base, in matrix format, and a software routine which interacts with the UT design representation (model-base) with a finite set of test and measurement data to diagnose faults through interpretation of test results. The UUT design representation, generated automatically by the Diagnostic Analysis and Repair Tool Set, is in a Fault/Symptom Matrix format. The Fault/Symptom Matrix is a mapping of all possible failure locations to the information, or test data, that imply each specific fault. The software routine makes use of set covering algorithms and cones of evidence to relate the test information to the mapping provided by the matrix.

The Diagnostician is useful for a multitude of mission essential functions including: fault management, reconfiguration, and virtual prototyping.

The Diagnostician can be embedded within prime system hardware to provide self-sustained diagnostic capability and/or can be embedded within a piece of automatic test equipment to act as the diagnostic test program set.

In the Test Program Set application, the need to develop extensive, lengthy diagnostic test programs is minimized. The reduction in the number of diagnostic test programs is accomplished by utilizing the Diagnostician tied to the functional, or end-to-end programs, which are normally developed for factory testing or acceptance testing. The functional test program includes a series of tests and measurements which determine if the unit is operating within specified performance levels. By logging the results of these individual tests and measurements, the Diagnostician can interpret the results into diagnostic information. In many cases, no additional tests will be required to achieve fault isolation. In cases where, based upon the results of the functional test, an ambiguity group exists, the Diagnostician will make calls to the test program set to execute those tests, and only those tests, which will provide diagnostic resolution.

In the embedded application, the Diagnostician can be hosted on any embedded computer or microprocessor. It can interact with any performance monitoring and sensor data, including data directly off a 1553 or 1149.1 bus.

5.2.14 Test Economic Services

5.2.14.1 Economic Modeling Tools

The Economic Modeling Tools are EXCEL spreadsheets that allow the user to enter details of a board or ASIC design and observe the effects on the cost of production quantities of the product. The board design analyzer includes a comparison of two alternative approaches to test implementation, ATE and BScan, and allows the user to determine the cost effectiveness of BScan DFT insertion. Test strategies for each case are defined by the user. The tools are very interactive and perform a “real time” “what if” capability which gives instant reaction to user selected changes to design factors. The tools present many parametric cost charts as part of the spreadsheet output.

5.2.15 IKOS

5.2.15.1 Voyager FS

IKOS Voyager FS provides concurrent fault processing in software comparable in performance to special purpose hardware fault accelerators. It uses the same sign-off and certified IKOS ASIC libraries as used by Voyager CSX and Gemini CSX. It provides mixed-level fault simulation with VHDL test bench methodology, in addition to traditional vector-based fault simulation. The WGL, EDIF and VERILOG(TM) formats are supported for import for classical design flows. There is full timing fault simulation for multi-phase clocks, multiple strobe points, and feedback loops

5.2.16 ZYCAD

5.2.16.1 Fault Simulation Accelerator

The Fault Simulation Accelerator from ZYCAD may be used.

6. ENTERPRISE SYSTEM TOOLS

6.1 Enterprise System Overview

An enterprise system provides the tools and facilities for managing and providing access to the enterprise information and integrating the automated processes of an enterprise. The enterprise system for RASSP is defined as the integrated set of tools and facilities required to support the development of a signal processor prototype - design, manufacturing, test, management, procurement, etc. The RASSP enterprise system enables the integration of the tools used in the various stages of the development of a signal processor, using a workflow management tool and an enterprise-wide product data manager. It supports integrated product development by providing an infrastructure to support concurrent engineering in a distributed environment. Users are supported by a desktop environment that provides services to support interaction with either individual tools or groups of related tools coupled with specific frameworks. The enterprise system provides support services enabling users to interact with other users on common internal networks. In addition, the enterprise system supports interaction with external system users, such as team member organizations, manufacturing centers, and external suppliers who are members of the concurrent engineering development team.

The RASSP enterprise system implementation is based on commercially available tools, database systems, product data management systems, workflow management systems, network technologies, and related applications. The enterprise system provides a highly productive development environment that enables designers to focus their development tasks on the target designs-providing a degree of isolation of the designers from the detailed translations and information management functions required to support design processes.

6.2 Enterprise System Tools

The enterprise system toolset includes the following:

- DMM (Design Methodology Manager) from Intergraph is used to execute workflows (methodology) defined for a project or a high level task such as detailed design.
- AIM (Asset and Information Management) a Metaphase based PDM from Intergraph is used to manage product information across the enterprise.
- Explore (CLMS) from Aspect classifies, manages and cross-references all component, supplier and design data and automates the processes associated with this information, as well as the VIP Family of Component Reference Databases.
- IIB from Sandpiper Software, Inc.
- TriTeal Enterprise Desktop (TED) from TriTeal is a graphical desktop environment that provides independence from the underlying operating system and hardware.
- MI (Manufacturing Interface) from SCRA is a standards based capability to perform design-for-manufacturing analysis and perform data translations between design and manufacturing tools.
- Communiqué and Cooltalk by Insoft support a wide variety of information exchange mechanisms to support collaborative work.
- Netscape Enterprise Server from Netscape provides secure communication and browsing capabilities over the Internet.
- PGP from Viacrypt allows users to ensure that their messages are read only by intended recipients by using public key encryption.
- WorkExpert from Mentor is used to execute workflows to automate tasks.

- ProSim from KBSI is a process modeling tool used to capture processes and tasks related information. ProSim generates models that can be simulated by simulation tools such as Witness.
- Witness from AT&T is a discrete event simulation engine that provides capabilities to perform what-if analysis and evaluate alternatives based on simulation results.
- MS Project from Microsoft is used to perform project planning, scheduling, and tracking.

6.2.1 Intergraph

6.2.1.1 Design Methodology Manager

Design Methodology Manager (DMM) guides you through your design process while managing the relationships between the various tasks in the process. This reduces error propagation and trims design cycles. Included within DMM is a workflow builder for defining the process model, and an Application Procedural Interface (API) for custom integration of external applications. DMM comes with a collection of software utilities and a graphical user interface that allows you to easily encapsulate your own applications.

Process workflows reduce the learning curve and increase productivity.

Allows designers to focus on the creative side of design rather than on the mechanics of using design automation tools. This dramatically increases designer throughput.

- Intuitive, workflow-based user interface jump-starts the user.
- Reduces relearning of design tools as engineers move from project to project.

Easy Application Encapsulation

With DMM, you don't have to be a software engineer to encapsulate applications. DMM's graphical user interface allows anyone to encapsulate most common applications.

Control and Track Design Processes

Some design processes span two or more companies or multiple groups in the same company. In this case, your design processes may have to be enforced to ensure that required design practices are followed for projects to be completed successfully.

- Ensures correct design process.
- Maintains a history and audit trail.

Lowers Your Cost of Ownership

Interoperability across UNIX and Microsoft Windows platforms enables you to leverage your existing hardware and software investments.

- Databases are binary compatible across platforms and operating systems.
- Consistent look and feel across platforms and operating systems.

Features

Graphical Process Builder

- Graphical workflow generation and editing.

- Inter-task relationships specified in forms.
- Supports any combination of serial, branching, concurrent, or looping processes.
- Supports multiple branching operators.
- Links to project management tools such as those supplied by Microsoft.
- Scalable, single-user or enterprisewide process workflows.

Intuitive Design Workflows

- Supports workflows that are process, project, or design-specific, or that apply to a company globally.
- Graphical view of task sequencing provides information for scheduling purposes as well as process tracking.

Advanced Capabilities

- Administrative capabilities allow selected users to reset workflows.
- Application Programming Interface (API), which consists of “C” function calls, allows VBDMA to be integrated into third-party applications.
- Supports export of history information to third-party spreadsheet packages and project management tools.

Data In

- Any data in industry-standard comma-separated value (CSV) file format.

Data Out

- CSV file format.
- State information and compiled workflow data for use by Design Methodology Manager and the Administrator.

6.2.1.2 Asset and Information Management (AIM)

The Intergraph Asset and Information Management (AIM) is a Product Data Management (PDM) system that is based on the Metaphase PDM system from Metaphase Technologies. Key components of AIM are AIM/Server, AIM/Manager.

AIM/Server is the server-based component for AIM, Intergraph's enterprisewide Asset and Information Management solution. AIM/Server provides an object-oriented framework that includes architectural components for data indexing storage, query, security, and usage control. Full-text retrieval indexing (AIM/FTR) is also available for AIM/Server. This architectural framework creates a graphical work environment to help users quickly locate and use documents. Not only will AIM/Server manage information, but it will also ensure that access to information is controlled and information integrity is preserved throughout the life cycle of a document.

AIM/Server performs many object management functionalities including administration of users, groups, and hosts; a generic set of object classes and relationships; object creation, storage, vaults, and queries; and a rule-driven security mechanism. AIM/Server uses a relational database for maximum efficiency and security.

Features

- Object-based architecture.
- Data model represented as predefined objects and classes.
- Management of CAD files and their reference files, such as Intergraph's Solid Edge[®] and Imagineer[®] Technical.
- Automatic support of file relationships for EMS, .DWG, .dgn, HTML, and CGM file types.
- Rules engine to enforce business processes.
- Graphical desktop paradigm and browsers.
- Logically centralized repository resident on one or many physical systems on mixed platforms.
- Bulk load utilities.
- Nested message groups.
- Generic set of object classes and relationships with associated rules and methods.
- Default processes for working with documents.
- Manipulation of frozen items.
- User-defined schedules for process execution.
- Rules-driven security mechanism.
- Multiple platforms support.
- Enhanced file sharing.
- Print without view capability.

Additional AIM/Server features include an object-storage mechanism for managed objects, database independence, and support for distributed databases and distributed metadata.

AIM/Server provides a dynamic data exchange (DDE) interface that enables external DDE-enabled applications, such as SAP, to communicate with the AIM system. The communication between AIM and external applications is performed through AIM/Manager, the client module of the AIM system.

AIM/Manager features a configurable graphical user interface that gives both technical and non-technical users a comprehensive solution for managing documents at their desktop. By providing an interface into the object data vault managed by AIM/Server, AIM/Manager allows easy management of multiformat files distributed across a mixed network of hardware, software, and databases.

AIM/Manager provides a wealth of functionality, including the ability to:

- Store, organize, and track documents, drawings, and other data.
- Create new documents.
- Combine similar documents into folders.

- Associate data files with documents, document groups, drawings, or folders.
- Conduct user-defined document searches.
- Check in, check out, copy, and delete documents and associated files based on security rules.
- Query for documents by full-text or keyword searches.
- Use proximity searching to perform queries for documents in the AIM system.
- Use a thesaurus to perform full-text retrieval queries for documents in the AIM system.
- Approve and sign off documents electronically.
- Participate in a workflow.
- Launch AIM/View and AIM/Redline for view and redline operations.
- Manage redlines created with AIM/Redline.
- Launch third-party editing packages.

AIM/Manager is a comprehensive solution for any organization's document management needs. The product will manage any type of document or drawing, including raster, spreadsheet, word processing, ASCII, and CAD files such as MicroStation and AutoCAD. The product also provides an open-system environment for document storage. Supported RDBMSs include Oracle and Informix.

Configurable Interface

AIM/Manager look-and-feel simplifies the process of managing documents. In conjunction with AIM/API, the user interface is configurable to suite the needs of a user, user group, user function or department, or company standard. The AIM/Manager window displays documents in one of three modes - tree view, icon view, and browse list view. The tree view provides a graphical representation of the documents and their relationships to other documents; the icon view displays a different icon for each type of document; and the browse list provides a scrolling list of attributes for each document. With simple pull-down menus and key-ins, new documents can be created and placed in the object vault. User-defined attribute information - such as document name, revision, and a description - is associated with the document and automatically maintained and managed by AIM/Server. Additional information is stored automatically when the document is placed in storage, including file size, date and time of check-in, and name of the user who checked in the document.

Through AIM/Manager, the user can create object-to-object associations to allow real-life representation of document relationships. AIM/Manager allows document access with little or no knowledge of physical storage locations, hardware platforms, or database systems. To retrieve a document, users can query the database by document name or any desired attribute.

To reduce the number of documents in a browse list, search filters can be specified. Filters can include the name of documents (including wild-card characters), descriptions, file type, check-in/check-out status (including documents checked out by a specific user), and other parameters.

As well as performing attribute searches, the user can search the contents of documents using a technology called full-text retrieval (FTR). With this technology, the user simply specifies a word or list of words that would be contained in the document and AIM/Manager will provide a list of documents that contain that word. Intergraph's full-text retrieval engine, AIM/FTR, is required on the server.

Simultaneous, Controlled Access

AIM/Manager increases the productivity of information by allowing simultaneous access of documents by multiple users. However, access to information is controlled according to user-defined security rules. AIM/Manager allows only one user at a time to check out a document for editing and markup purposes, but multiple users may simultaneously copy documents for view only. AIM/Manager automatically copies and retrieves files attached to drawings - such as MicroStation reference files - when the drawings are checked out.

Workflow Capabilities

AIM/Manager provides the ability to transition documents, drawings, document groups, or folders through user-defined workflows. With AIM/Workflow installed at the server, each document can be assigned its own workflow and transitioned independently of associated files.

The system is rules-based and can easily be configured to require user signoff before a document or drawing can be transitioned from its current state to the next state. AIM/Manager maintains a list of signoffs and a sign-off history for each document.

Scaleability

AIM/Manager provides a comprehensive system that can grow with customers' needs. It not only provides an interface into Intergraph's document management system, but can be combined with other AIM products and third-party editing software to provide a wide variety of document management and manipulation functions. AIM/Manager openness allows it to incorporate existing hardware and software to meet the diverse needs of individual workgroups or entire enterprises. Yet AIM/Manager is flexible enough to fit the specific needs of each user.

6.2.2 Aspect

6.2.2.1 Explore (CLMS)

The RASSP Reuse Data Manager (RRDM) is used to catalog and search for reusable design objects. Reusable design objects are also known as *Reusable Elements* (REs). Over one million design objects are currently managed in the RRDM. The RRDM is built on Aspect Development's **Explore (CLMS)** family of commercial off-the-shelf (COTS) products. Within RASSP, Explore (CLMS) has been integrated with Mentor Graphics' Library Management System (LMS) and Intergraph's Product Data Management (PDM) system.

Explore (CLMS) is primarily used in two phases:

- In early design, to look up and reuse fragments of existing designs, such as VHDL models.
- In detailed design, to choose the actual components that will be used within a design.

Explore (CLMS) supports RASSP-defined classification hierarchies of reusable elements that resulted from RASSP-funded research.

Aspect's CSM solution includes Explore (CLMS) client-server software which classifies, manages and cross-references all component, supplier and design data and automates the processes associated with this information, as well as the VIP Family of Component Reference Databases containing up-to-date information on over one **million** standard electronic and mechanical parts from over 600 suppliers.

Explore's (CLMS) 3rd generation object-relational architecture combines the flexibility of an object-oriented application with the power and security of an underlying commercial relational database engine (Oracle). Explore's (CLMS) flexible architecture allows customers to rapidly configure the system to integrate and leverage both internal business and technical data cross-

referenced with manufacturer reference data. Explore (CLMS) provides desktop access to a unified repository of consistent and current preferred parts, supplier information, and design data to significantly reduce product costs and time-to-market. Aspect also provides a complete set of legacy data migration and enterprise consulting services to accelerate the setup and deployment of enterprise solutions.

Aspect Development's Explore (CLMS) is used to:

- Hierarchically classify, categorize and retrieve part, supplier, and design information.
- Integrate and leverage internal business and technical legacy data in a unified repository cross-referenced with manufacturer reference data.
- Provides decision support to promote the reuse of existing internal preferred parts, suppliers and designs.
- Facilitate part and vendor volume consolidation, by identifying and eliminating duplicate and functionally equivalent parts.
- Identify single-sourced and multiple-sourced parts to drive supply chain management, strategic sourcing and commodity management.
- Automate and enforce the processes associated with requesting, approving, managing, obsoleting, sharing and reusing parts, suppliers and designs.

Classification of Parts, Suppliers and Reusable Designs

Explore (CLMS) makes searching for electrical and mechanical parts, suppliers, hardware and software design elements, CAD libraries, datasheets and other related information easy through the use of a hierarchical classification methodology. Objects are organized in a class hierarchy of classes and subclasses presented as a series of hierarchical folders. All classes have search parameters which define functional or business characteristics about the object. With Explore (CLMS) users can easily find and select parts, suppliers or designs by browsing the class hierarchy and entering search parameter values without knowing part numbers, commodity codes, coded text descriptions, spellings, and so on.

Aspect's 'Standard Classification Scheme' (SCS) is a pre-defined classification scheme that classifies standard electrical, mechanical and electromechanical parts as well as material, subsystems and accessories into classes and subclasses for easy search and retrieval. The standard parameter dictionary defines for each class, naming conventions (e.g., Microprocessor), parameters (e.g., technology = CMOS, vendor = Siemens) and legal values (e.g., power = 1 to 10 watts). Aspect's VIP family of component reference databases uses SCS to classify over one million parts. Customers also use SCS as the organizational framework for managing internal standard and custom parts with technical and business parameters and to cross-reference internal standard parts to one or more commercially available manufacturer parts contained within the VIP family of component reference databases. The SCS is based on IEC, ISO, EIA, JEDEC and other standards.

Explore (CLMS) supports any number and levels of classes, subclasses and search parameters. Customers can create new classes, subclasses and search parameters or modify the classes, subclasses and search parameters provided with SCS. Classification is achieved via an object-oriented model, while the information is stored in a commercial relational database (Oracle). Class and search parameter data modeling is accomplished dynamically through the graphical user interface while the system is on-line and doesn't require a database administrator or programmer with SQL or programming experience. Once the model is defined, Aspect's Soft Model technology will automatically create the underlying relational tables and build the application on-the-fly without recompiling. No software programming is required.

Viewing the class hierarchy is achieved through the Class Browser. Explore (CLMS) supports multiple class browsing modes to provide an easy to use, intuitive interface for a range of users from the infrequent user to the power user. In *Hierarchical Class Browsing* mode the Class Browser shows the class hierarchy as a series of nested folders. Folders can be expanded or collapsed by simply pointing and clicking on the folder icons to navigate through the class hierarchy. In *Power User Mode*, users simply type in the class name or a fragment of the class name, instead of clicking through multiple folder levels, the class browser automatically jumps to display and highlight the typed-in class. In *Flat Class Browsing* mode, classes are organized and displayed alphabetically, users can then scroll through the list or use the power user mode to jump directly to the desired class.

Explore (CLMS) provides a simple yet powerful parametric search engine. Simply select the desired item class in the browser and press the quick search button to display a list of those items. Furthermore, you can qualify the list of items retrieved by entering search parameter values. The customer can search on parameters provided with SCS or on customer define technical and business parameters. Example search parameters include part number, generic part number, manufacturer, supplier, description, technology, package style, cost, lead time, status and dozens of other technical and business search parameters and any combination of the above. Search shortcuts include wildcards, ranges, logical and numerical operators, pick lists and unit-of-measure conversion. Explore's (CLMS) object-oriented architecture supports full parameter inheritance, search parameters declared at top-level classes are inherited down to the bottom-level leaf classes, allowing users to do parametric searches at any class level in the class hierarchy. Search results are viewed in horizontal or vertical tables as shown in Figure 6.2-1.

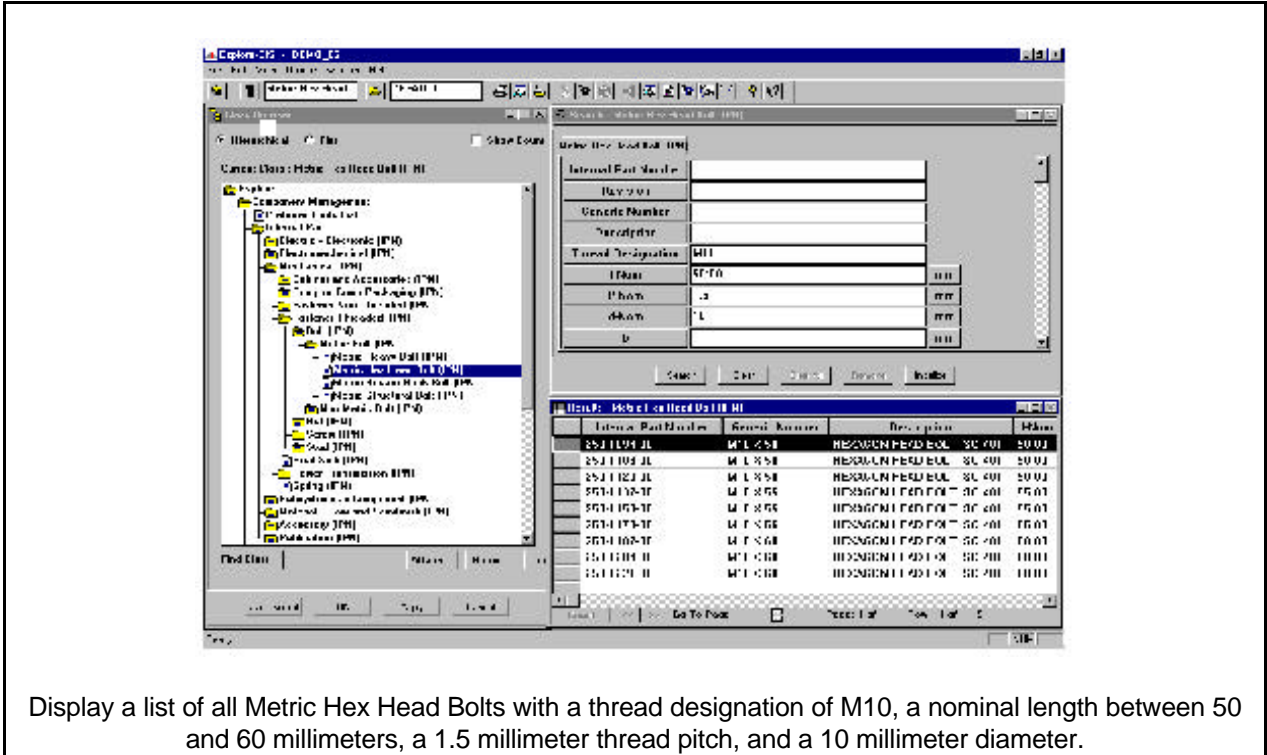

Display a list of all Metric Hex Head Bolts with a thread designation of M10, a nominal length between 50 and 60 millimeters, a 1.5 millimeter thread pitch, and a 10 millimeter diameter.

Figure 6.2-1. Search results screen.

Third-Party Integrations

Explore (CLMS) is integrated to the following software:

- Mentor Graphics' LMS.
- Cadence's Concept.

- Metaphase Technology's Metaphase 2.2 (PDM system).
- NDG's SwiftView (viewing tool).
- Netscape's Navigator 2.02 (WEB browser).
- Future integrations are planned with leading ECAD, MCAD, PDM, and ERP/MRP tools.

6.2.3 Sandpiper Software, Inc.

6.2.3.1 RASSP Reuse Data Manager (RRDM)

The RASSP Reuse Data Manager (RRDM) consists of a client browser, a "perspectives" application server (including the search and vocabulary mapping engines), and multiple source data repositories. A designer looking for reusable design knowledge browses the hierarchy and identifies a potential source for designs of interest. Then, through a custom view of the common vocabulary, the user may specify attributes of the candidate design(s) he or she is interested in. Queries may include arithmetic expressions, logical expressions, attributes of related classes, and constraints on any of the attributes, as appropriate. Mapping algorithms that account for a variety of data inconsistencies, differences in precision, translation of units of measure, and other distinctions among terms across repositories are resolved to the user's customized vocabulary and display requirements. The search of available (and optionally selected) source repositories is performed in parallel, with meta-data for all results displayed through the client browser. Depending on the number and nature of the results returned, he or she may further refine the search by specifying additional attributes and/or more restrictive criteria. Objects of interest may be selected and the corresponding designs (e.g., schematics, drawings, models) displayed in their native tool environments given that appropriate resources are available to the user.

The key capabilities are:

- Data Modeling
- Search and Retrieval
- Heterogeneous Integration
- Distributed, Object-Oriented Architecture

The underlying knowledge engine that manages the common vocabulary, maps that vocabulary to the various distributed sources of reusable engineering design data in the environment, and provides a common user interface/single entry point from which users can search for, view and access candidate designs and related information is known as the Sandpiper Software Intelligent Information Broker (IIB).

The environment in which the RRDM operates consists of the following components:

- One or more sites, where users and/or source databases, applications, file systems, or other source information resides, connected by local and/or wide area networks.
- Multiple client systems and one or more back-end database servers which contain hardware and software from a variety of vendors.
- Back-end databases of varying content, organizations (i.e., schemas) and underlying DBMS engines (relational, object-relational, object), related to one another in both tightly-coupled (i.e., with similar schemas) and loosely-coupled (potentially having little or no similarity among them) federations.

End users include, among others, designers who interact with the system directly or through integrated applications such as product data management (PDM) systems, workflow managers, CAD tools, or other systems in their environment.

The intelligent information broker (IIB) provides the capability for users to search for and retrieve design knowledge (or other related engineering and business information) stored in their distributed environment through the common vocabulary. This vocabulary is implemented as a group of internal repositories of descriptive information that describe the terms defined for the domain, the locations, and characteristics of source repositories, characteristics of the mapping from source repositories to the common vocabulary, user authentication information, and so forth. The IIB provides the capability to search stored meta-data for design knowledge, regardless of whether the objects themselves are managed by the broker or externally.

The information broker (shown as an "application server") acts as middleware, integrating end users (or "clients") with the various sources of design knowledge in their virtual environment. IIB functionality has been partitioned between the application server, Java™ applets integrated with the user's Web Browser, and the source database servers that comprise the cooperating environment. Integration of external applications is enabled through Common Object Request Broker Architecture (CORBA) application programming interfaces (APIs).

Figure 6.2-2 highlights the prototype IIB architecture as implemented in the RASSP environment. As mentioned above, users interact with the system either directly through a Java™-enabled web browser or through other applications that have been integrated with the IIB through CORBA-compliant APIs.

At the heart of the IIB is the Perspective Server, which provides the intelligent search and information brokering function in support of user requests. From these user requests, it generates queries to the associated source repositories. The Perspectives Server maps the user's query from either the common vocabulary or a customized, user-specific vocabulary to the physical back-end repository implementation notation (e.g., SQL, C++), returning the requested data to the user in a user-specified format.

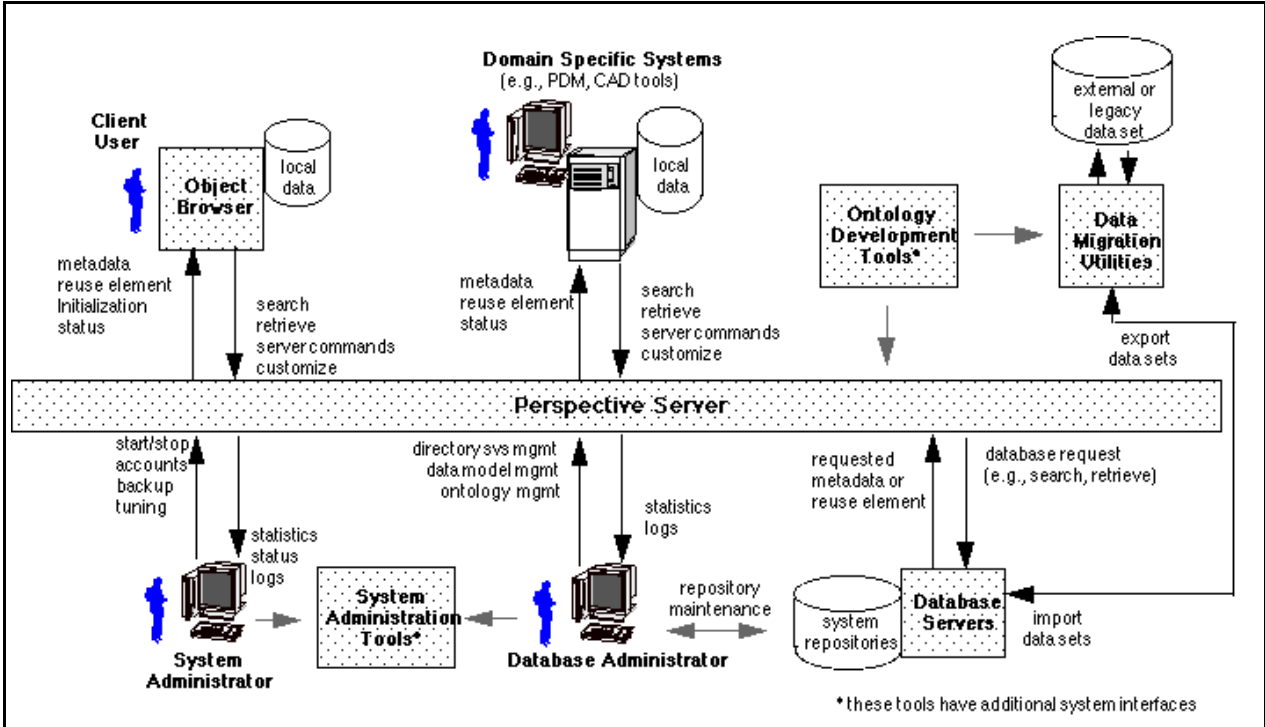

Figure 6.2-2. Sandpiper Software Intelligent Information Broker Context.

The IIB provides native support for sets of tightly-coupled back-end database servers. These tightly-coupled federations have similar schemas and may be mapped to one another and the common domain vocabulary through a single source vocabulary. For source repositories that are sufficiently dissimilar, separate (distinct) source vocabularies will be integrated with the IIB. A single federation of source repositories may be represented by multiple vocabularies, each providing different views (e.g., by a standard by taxonomy, function, by product) of the underlying data. User selection between these views enables access to the data in a manner most appropriate to the task at hand.

The Perspectives Server also describes the mapping between the user's preferred view and the common vocabulary for a domain. The user's custom view may include attributes from multiple classes, constraints on display characteristics, such as preferred currency or units of measure, and so forth. These views are also encoded as ontologies based on Ontolingua and KIF.

Planned Enhancements

A number of additional capabilities are planned for the commercial product and subsequent releases by Sandpiper Software, Inc. These include:

- Function-Based Search and Retrieval.
- Content-Based Search and Retrieval.
- Configuration Management for all ontology components and meta-data with optional release management for design knowledge.
- Fine-Grained Authorization Control.
- Enhanced User Authentication.
- Extensive User Customization Capabilities, including user and role-specific views of the virtual repository as well as support for custom forms, templates, and reports.
- Standards-based application integration for third-party tools through CORBA-compliant APIs, including automated data synchronization where required.
- Multi-vendor DBMS support (relational, object-relational, and object databases).
- Intelligent agent integration for data mining and decision support, subscription, notification, and other extensions to the baseline technology.

6.2.4 TriTeal

6.2.4.1 TriTeal Enterprise Desktop (TED)

The TriTeal Enterprise Desktop (TED) is a graphical desktop environment that provides independence from the underlying operating system and hardware. It provides a OSF/Motif compliant window manager and libraries to enable the execution and development of OSF/Motif applications. Common desktop activities have been encapsulated into an icon-based graphical interface that employs intuitive drag and drop techniques.

TED provides a tightly integrated suite of applications for common activities. TED provides a customizable "front panel", a file manager, an application manager, a style manager, an e-mail interface, a calendar manager, a WWW browser, FAX manager, and an extensive help system. All of these work together to provide a seamlessly integrated interface. The front panel is the launch point for most applications and many desktop controls. It is fully customizable to facilitate easy access to most commonly used applications. The application manager allows access and control of every application in one convenient location, including applications that reside on the

network. The file manager allows easy access and quick navigation of the filesystem. Files can be associated with applications via several different paradigms so that access to a particular file is as simple as double clicking. The calendar manager allows scheduling of group events and has multiple notification methods. All of these applications, along with the WWW browser and fax manager, are drag and drop compatible with each other which makes for a very intuitive interface. TED also includes an integrated virtual desktop environment that allows a user to have more than one desktop environment sharing the same physical screen. This allows a user to tailor each virtual desktop to the specific needs of a particular application or activity. It reduces desktop clutter by hiding the windows and icons of other applications that are present on other virtual desktops.

6.2.5 SCRA

6.2.5.1 Manufacturing Interface

The overall mission of the RASSP Manufacturing Interface is to enable first-pass manufacturing success of application-specific signal processors. To achieve this goal, concurrent engineering techniques must be used between design and manufacturing to ensure that manufacturability is built into designs from the beginning. This level of communication and cooperation can be achieved most effectively in the context of a “virtual enterprise”. The information sharing infrastructure that forms the backbone of a virtual enterprise can only be achieved through the development, acceptance and adherence to information sharing standards such as VHDL, EDIF, and STEP.

The Manufacturing Interface being developed by the SCRA Team provides seamless integration of design and manufacturing as well as supporting Integrated Product/Process Development (IPPD). By providing an IPPD capability, the Manufacturing Interface allows design prototypes to be produced more quickly. By using a standards based interface, the RASSP Manufacturing Interface supports virtual partnering between design and manufacturing organizations.

At the heart of the Manufacturing Interface is a novel concurrent engineering capability. The principle focus of this capability is to enable an effective DfX capability by creating an IPPD environment. This Concurrent Engineering (CE) environment is distinguished from other CE environments in two respects. First, it utilizes a standards-based methodology to create the information sharing infrastructure necessary for IPPD. Second, it provides a unique, knowledge-centered approach to concurrent engineering. This is accomplished by integrating an inference engine into the standards-based information sharing environment. The result is an automated concurrent engineering capability. This capability allows engineers from different disciplines to capture their experience in an executable form. This executable knowledge may then be used to detect potential producibility, testability, and other “ility” issues early in the product development process.

The Manufacturing Interface is composed of several distinct tools. The Manufacturing Resource Editor (MRE) is used to capture the capabilities of a manufacturing facility in standard form. The Mentor-to-STEP Data Converter tool is used to convert Mentor design files into standard STEP files. The STEP product data is used by a Producibility Advisor in conjunction with manufacturing capability information captured by the MRE to determine any issues against the design based on the manufacturing production line chosen. The product data and manufacturing capabilities are also used by the Process Planner to create a manufacturing process plan. Manufacturing and design issues are resolved via the Web-based Access Mechanism and collaboration tools. A secure Internet connection will be used to transfer data between design sites and the Ocala manufacturing site.

In Build 2, support for EDIF 4.0.0 is being added to the standards-based interface. Also, Mitron's CIMBridge manufacturing support system is being integrated into the Manufacturing Interface, providing more robust DfX analysis capabilities and commercially supported Numeric Control (NC) program generators. The architecture of the Manufacturing Interface is shown in Figure 6.2-3.

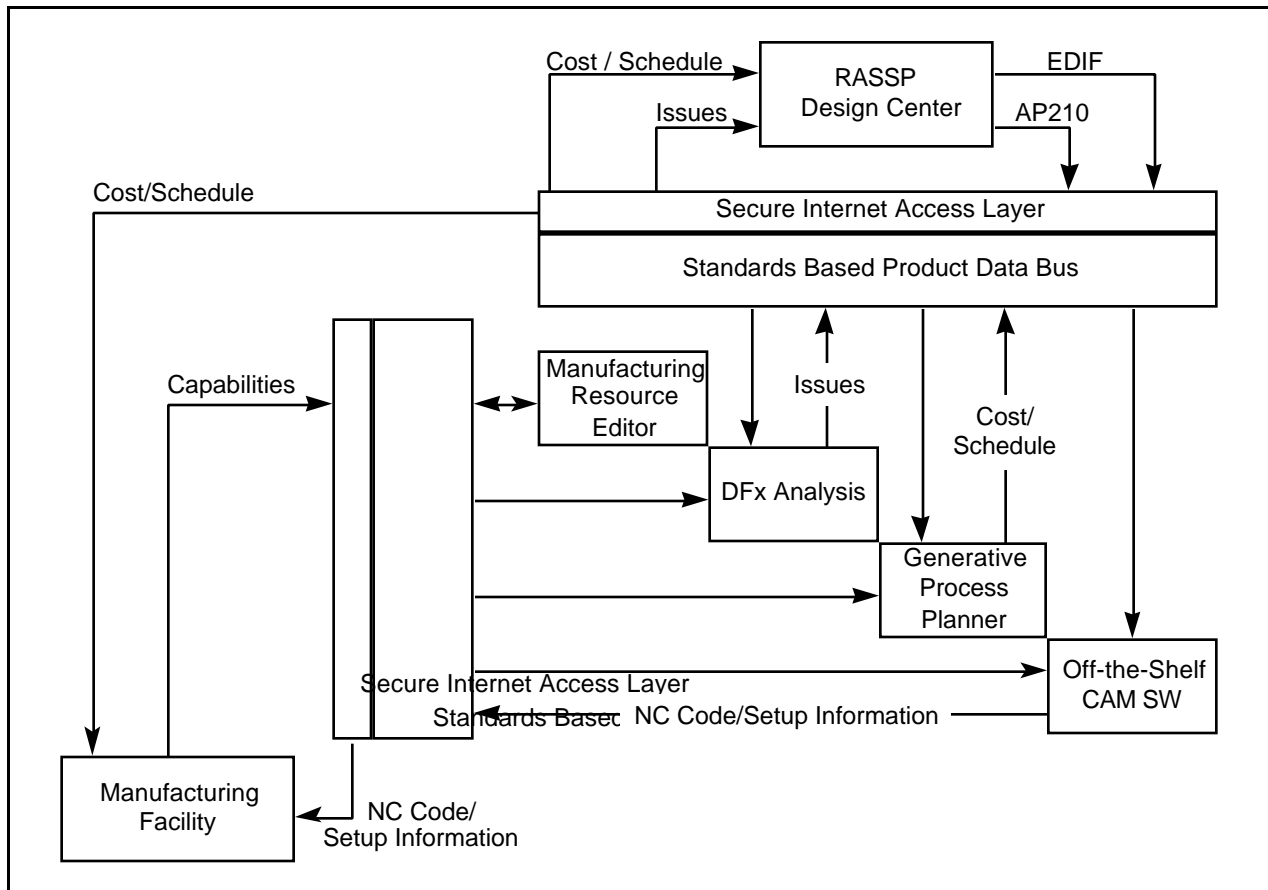

Figure 6.2-3. RASSP manufacturing interface architecture.

Ultimately, the capabilities embodied in the Manufacturing Interface will enable concurrent engineering in the context of the electronic commerce paradigm. Figure 6.2-4 illustrates how this will be accomplished. The initial design customer contact with the manufacturer takes place via a public World Wide Web (WWW) connection. If further contact is desired the customer registers with the manufacturer and is given access to a secure WWW server. The customer may then transfer design data via secure Internet to the manufacturing site and use a web browser to run the design data against the manufacturer's capabilities. Manufacturing issues and relative pricing are returned to the customer via the secure WWW connection. If additional manufacturing knowledge is required, the customer may request assistance from a manufacturing engineer. Additional iterations of this scenario may be required before a satisfactory design is obtained. When the design is complete, the customer contacts the manufacturing engineer for detailed cost and scheduling information and data verification.

6.2.6 Insoft

6.2.6.1 Communiqué and Cooltalk

Collaboration is a term which is used to describe the interaction between participants in the RASSP design and development process. Specific tools are sought which improve the efficiency and quality of information exchange between individuals, while at the same time providing a communications platform used in conjunction with other on-going RASSP initiatives.

Two collaboration tools have been identified and implemented. These can be used with other RASSP Enterprise capabilities, e.g., the Manufacturing Interface function. The collaboration tools used, Communiqué and Cooltalk by Insoft, support a variety of exchange mechanisms. Included

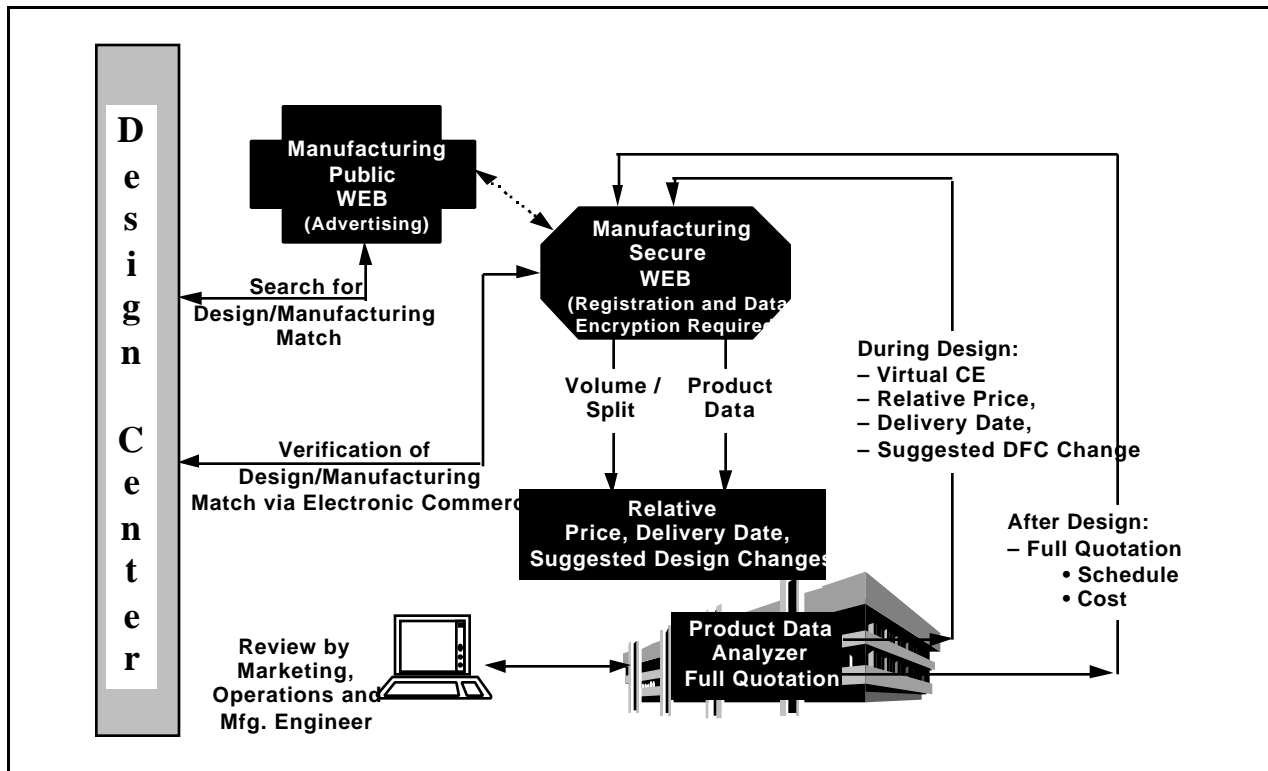

Figure 6.2-4. Supporting electronic commerce.

are a series of "tools". The tools are: Chat Tool, Audio Tool, Whiteboard Tool, TV Tool, Information Exchange Tool, and Image Tool. The only substantive difference between Communiqué and Cooltalk is that Communiqué includes the TV Tool and Cooltalk does not. In addition, Communiqué is a standalone product whereas Cooltalk has been bundled with the new version of the Netscape Navigator web browser. Any subset of these "tools" can be used in a specific application. In some cases the tools employed may not include the complete suite due to network firewall limitations. In particular, both the Audio and TV Tools are User Datagram Protocol (UDP) based, which are normally screened by corporate firewall implementations. The remaining tools are Transmission Control Protocol/Internet Protocol (TCP/IP) based and more likely to be supported. Nonetheless, any one of the aforementioned tools provides a significant enhancement of the information exchange capabilities between participants in the RASSP workflow process. A brief description of these tools follows.

A Communiqué Conference is first established by one individual. Other individuals are in turn invited to join the conference. Some initial coordination must first be established to ensure that each user has his or her Communiqué software executing, as this is a pre-requisite. The conference initiator issues invitations to others who in turn accept these invitations. In this manner the conference is established where any or all participants can then invoke specific tools. Each tool invoked is accessible or visible to each conference attendee. For example, if a chat session is initiated, each participant has an opportunity to view the chat exchange and join in, if desired.

The chat tool generates a viewable window which displays typed text by each participant, with a user name preceding each entry. The audio tool provides the ability to conduct an audio teleconference and requires the use of microphones and speakers at each participating workstation. The whiteboard tool enables the use and display of a shared whiteboard application where each participant can generate graphic symbols, text, freehand sketchings, and import graphics. This tool is extremely valuable when used in the context of evaluating detailed design material. The TV Tool is the video equivalent of the audio tool and requires that the

workstation(s) is equipped with a camera. Setup parameters can be adjusted to configure the degree of audio/video synchronization. When this function is working properly over communications links possessing sufficient bandwidth it is as if the individuals are collaborating in physical proximity. The information exchange tool allows users to exchange and view data contained on floppy disks or CDs.

6.2.7 Netscape

6.2.7.1 Netscape Enterprise Server

Another network initiative being undertaken is the establishment of secure network communications. It is the goal of RASSP Enterprise infrastructure to implement tools which expand other associated capabilities of RASSP without compromising data and by protecting privacy of communications. This takes several forms. It includes the addition of a secure communications layer on top of World Wide Web transactions. This function provides for encrypted client/server sessions. Thus, using the WWW HyperText Transfer Protocol (http) as a transfer medium, RASSP related information may be hosted on a secure server. By combining with already existing http authentication schemes, confidential design information can be made available to selected users which is protected against unauthorized access.

The specific tool used to implement secure WWW sessions is Netscape's Commerce/Enterprise Server. This server uses Secure Sockets Layer (SSL) protocol to encrypt client/server sessions. It uses Public Key encryption technology. Encryption keys are exchanged by server and client when a session is initiated. A one-time session key is also used to ensure uniqueness during an individual session. The encryption session is performed transparently by client and server with no overt action required by the user of the client browser. Thus, in order for the sessions to be "private", authentication is built on top by means of tailored HyperText Markup Language (HTML) coding. This involves the use of user names and passwords, whose exchange is automatically encrypted.

6.2.8 Viacrypt

6.2.8.1 Pretty Good Privacy (PGP)

Another component of secure communications is the use of Pretty Good Privacy (PGP) email and data encryption schemes. This function uses Public Key encryption technology along with a simple graphical user interface (GUI) to allow users to ensure that their messages can only be read by intended recipients. For data, it can be used to encrypt data files prior to their staging on a network server. This ensures that confidential data is protected from unauthorized access.

Note that PGP comes in two varieties: freeware version and commercial version. The freeware version is available to individuals and the commercial version is for use by businesses. These versions are fully interoperable with one another.

6.2.9 Mentor

6.2.9.1 WorkExpert

The WorkXpert Tool Suite offers a complete work flow design environment for engineering design teams, and project managers.

FlowXpert™

- Manages process execution.
- Monitors and controls process dependencies.
- Provides point and click access to tools and utilities.

- Deploy standard, repeatable processes.
- Graphical views of your processes for easy understanding of project status, tracking of task and data conditions, and highlighting potential process.
- Flexibility to execute processes without any constraints or controls. As the "end game" approaches, appropriate task and data dependencies can be applied.
- Productivity features such as a report builder, shared white board, and attachment of annotations anywhere, anytime.

XpertBuilder™

- Efficiently captures your processes.
- Open architecture that supports any tool.
- Test mode for the easy debugging of your workflows.
- Translate documented processes into executable workflows to deploy best practices throughout an organization.
- Graphical drag-and-drop editing environment provides intuitive, easy-to-use features to capture workflows.
- Cut and paste to reuse flow templates across multiple projects.
- Create hierarchical process flows with unlimited nesting of task and subflow hierarchy.
- Graphical interface provides easy access to complex task and data dependencies, easing the problems of process development.
- Create custom or company-specific look-and-feel standards for processes.

ProjectXpert™

- Track key project deliverables.
- Whole project status at a glance.
- Automatic capture of process metrics.
- Import/export of project schedules.

Managing Your Work Process

The growing complexity of the design process increases the need for better process management. As the number of design tasks and the relationships between them increases, more and more time is required to move the design through the process. A way to quickly identify the appropriate tools, data, and people for any given phase of the work becomes critical. The WorkXpert family of products allow engineers, designers, project and program managers to meet the latest design challenge in a fast-paced market. The WorkXpert family of products from Mentor Graphics offers the ability to capture, manage, and track best design processes.

6.2.10 KBSI

6.2.10.1 ProSim

ProSim is a process modeling product that enable users to capture, document, and analyze processes. Because both ProSim and ProCap are based on IDEF3, a government-endorsed, standard process modeling method, you can be sure that the process models you create will meet the documentation guidelines required by such programs as ISO 9000 and TQM.

ProSim adds the ability to record simulation goals, process time, resource utilization, costing, labor requirements, and setup time in a simulation model that's read by WITNESS, AT&T ISTEEL's simulation engine, for automatic simulation generation. ProSim validates models with options that are customized by the user. Errors are reported by the system allowing users to edit processes, re-allocate resources, and update decision logic before simulation is run.

ProSim has three windows in which models may be developed, edited, and analyzed. The Matrix Window is a spreadsheet-like interface that allows the user to quickly define the interaction between processes and objects. Details on different objects are easily captured and seamlessly incorporated into your simulation models. The Indented Nodelist is an expandable outline format that displays the hierarchical arrangement of higher-level and lower-level processes. This greatly simplifies both model construction and documentation, since you may view your model at varying levels of detail and complexity. The Diagram Window is a graphical representation of processes, their sequences, and their associated decision points.

Object State Transition Networks (OSTNs) can be constructed in the Object Window. This window illustrates an object and how it changes over its lifetime, and allows users to easily document the processes which trigger those changes. The powerful combination of process and object views, plus the ability to generate validated simulation models, gives you significant leverage in your knowledge capture, documentation, quality certification, and reengineering efforts.

ProSim version 2.1.5 was released May 1, 1996, and features:

- File Attachment Feature: attach files--such as documents, sound clips, or videos--to processes, junctions, objects, object states, project summaries, and diagrams.
- Export Capabilities: when exporting ProSim files, attachments to project elements will also be exported, allowing users with identical drive mappings to run the attached files.
- Time Saving Features: auto-routing/auto-placement for rapid model construction; multi-selection for streamlining and simplifying the modeling process; color coding in the Process/Object Matrix Window for simple identification of objects and processes; filters for rapid identification of used and unused elements in the project; specialized printing features; an upgraded toolbar; and automatic element resizing in the Diagram and OSTN Windows.

Use ProSim to:

- Capture not only processes, but the decision and timing logic involved in performing each of your company's processes.
- Create As-Is models for analysis of current processes, checking for areas of redundancy and opportunities for improvement.
- Create To-Be process models, based on your analysis.
- Automatically generate AT&T ISTEEL WITNESS simulation code with your ProSim simulation models.

- Change your To-Be models, after running simulation in WITNESS and analyzing the results, before implementing change.

6.2.11 AT&T

6.2.11.1 WITNESS

WITNESS is a process simulation tool used to assist in the evaluation of alternatives, either in support of major strategic initiatives or continuous improvement. A WITNESS model is a visual computer representation of a real life system. The model representation turns raw data into productive measures to support decision making. WITNESS provides the user with a broad scope of information on which to base decisions, predict outcomes, improve processes, analyze problems, and formulate solutions. It provides immediate feedback to various what-if scenarios, thereby shortening overall project time. Key WITNESS features are:

- Easy to use graphical interface.
- Ability to create sub-models.
- Supports physical, logical, and graphical model elements.
- Supports machine breakdowns and setups, labor, shifts, vehicles, and continuous processes.
- Supports file input/output, reports, plotting, and statistical analysis.
- Ability to create and conduct experiments.

6.2.12 Microsoft

6.2.12.1 MS Project

MS Project is a project planning and scheduling tool. It enables users to create a project work breakdown structure (WBS) for the project tasks. Create project schedules by assigning timelines to the tasks, typically, in the form of a Gantt chart. The task constraints can be incorporated to model task dependencies. The tool also allows assignment of resources to the tasks. A project manager can use this tool to create a project plan, create a schedule, and track project progress.

**APPENDIX A
RASSP BASELINE 2.0 — CAD SYSTEM TOOLS**

System Design

Tool Name	Supplier	Description
RTM	Marconi Systems	Lifecycle requirements traceability, impact assessment, requirements engineering and management tool
RDD-100	Ascent Logic	Front end design tool that aids the process of analyzing requirements, system definition, functional analysis and describing system behavior
RAM/ILS	MSI	Reliability, availability, and maintainability analysis tool for lifecycle support
PRICE	Lockheed Martin	Parametric cost models for SW and HW development programs
MATLAB	Mathworks	Algorithm development and numerical analysis tool
SPW	ALTA	Signal processing algorithm behavioral simulator
BONeS		Architectural simulation, trade-off analysis, performance verification and evaluations, and resource modeling tool
Tech. Pub. Software	Interleaf	Document generation and publishing tool for creating text and graphics
Explore (CLMS)	Aspect	RASSP design component info system

Hardware/Software Co-Design

Tool Name	Supplier	Description
RTM	Marconi Systems	Lifecycle requirements traceability, impact assessment, requirements engineering and management tool
RAM/ILS	MSI	Reliability, availability, and maintainability analysis tool for lifecycle support
SavanSys	Savantage	Trade-off analysis tool for packaging and interconnection of high performance electronic systems
NetSyn	JRS	Partitioning and scheduling tool for network synthesis and integration of all architecture tools
PTOLEMY	BDTI	Supports multi-domain analysis of complex systems
PRICE	Lockheed Martin	Parametric cost models for SW and HW development programs
GEDAE™	Lockheed Martin ATL	Testbed environment for application development
AIB		Application Interface Builder
MATLAB	Mathworks	
QuickVHDL	Mentor Graphics	VHDL simulator
EDAnavigator	Harris EDA	Trade-off analysis tools for packaging and partitioning of high performance electronic systems
SPEAR	AT&T	Parallel processor debugger & autocode generator
PIE	U. of Oregon	Software performance analyzer
SPW	ALTA	Signal processing algorithm behavioral simulator

Hardware/Software Co-Design (cont.)

Tool Name	Supplier	Description
BEACON	Applied Dynamics International	Used to generate code for the command program, test vectors for unit tests as well as product documentation
SimMatrix	Precedence	Integration environment which allows multiple simulation engines to run concurrently
Autocode Toolset	MCCI	Autocode generation and runtime system for graph execution control
RDD-100	Ascent Logic	Front end design tool that aids the process of analyzing requirements, system definition, functional analysis and describing system behavior
COSMOS PMW	Omniview/Honeywell	Performance Modeling Workbench (PMW) creates alternative hardware/software architectures and simulates them to validate system performance
Object GEODE	VERILOG	Enables the generation, verification, and validation of target code for the command program

Hardware Design

Tool Name	Supplier	Description
FALCON	Mentor Graphics	Framework for Mentor and selected third-party tools; includes Design Manager, BOLD Browser, Common User Interface, Decision Support System, AMPLE, Notepad, Design Viewpoint Editor, Design Dataport, Parts Reporter, FALCON libraries, Quickparts Timing Editor, Sim View, EDDM to VHDL netlister ... and others
Design Architect		Design capture environment for architectural, logic, and/or circuit levels
Library Manager/Library User (LMS)		Component Library manager for parts librarians and users that supports a structure for controlling the development, maintenance, and use of models
PLD Synthesis II		Optimization and synthesis tool for designing FPGAs, CPLDs, and PLDs
QuickPath		Interactive static critical timing path analyzer
QuickVHDL		Direct-Compiled code interactive VHDL simulator
Board Designer		Place and route of PCBs, interface to manufacturing tools
MCM Station/Quad Tools		Supports multichip module design with integrated high-speed layout tools and advanced packaging techniques and crosstalk analysis
AutoTherm		Thermal analysis tool
SimMatrix		Precedence
TDS	Summit	Tools for simulator data translation to module tester format and tester program generation
Visual HDL		VHDL entry via graphical means
IDEA-S	SDRC	Mechanical 3-D solid modeling and finite element analysis
RDD-100	Ascent Logic	Front end design tool that aids the process of analyzing requirements, system definition, functional analysis and describing system behavior

Hardware Design (cont.)

Tool Name	Supplier	Description
VHDL Compiler	Synopsys	VHDL source compilation
Design Compiler		Logic synthesis
Design Ware		The Design Ware family of products includes tools for a design reuse strategy which is highly integrated with the Synopsys synthesis environment
LM		Provides hardware modeling capability
SmartModels	Logic Modeling Group (LMG)	Standard component behavioral models from SSI to VLSI complexity
SourceModels		Complete VHDL libraries of SSI, MSI, and memory components, including VHDL Test Bench with each model
Hardware Models		Models for LMC's LM family of hardware modelers
System Realizer Family	Quickturn	Quickturn's hardware emulation system provides ASIC "Computer Aided Prototyping" by reading any design netlist, automatically partitioning, placing and routing an array of FPGAs free of any timing violation
VICTORY	Teradyne	Fully automates test generation for boundary-scan devices in boards or modules using full or partial scan technology
VHDL Cover	VEDA Design Automation, Inc.	Analyzes VHDL code; can be used for test vector coverage analysis
FPGA Foundry	NeoCAD	A device-independent toolset for the implementation of Field Programmable Gate Arrays (FPGAs)
SavanSys	Savantage	Trade-off analysis tool for packaging and interconnection of high performance electronic systems

Design-For-Test

Tool Name	Supplier	Description
TDS	Summit	Tools for simulator data translation to module tester format and tester program generation
Test Compiler	Synopsys	Combines test synthesis, ATPG, fault simulation, and test management to automate DFT
VICTORY	Teradyne	Fully automates test generation for boundary-scan devices in boards or modules using full or partial scan technology
LASAR		LASAR will be used in conjunction with other tools to aid in developing appropriate test vectors for functional, toggle and fault tests. Its min-max simulation capability will minimize the amount of time spent debugging test programs on testers or in target systems
TSTB WAVES	Rome Laboratory	Automates the generation of a complete VHDL-WAVES Testbench for VHDL designs using the WAVES standard
WSTA	Naval Undersea Warfare Center	Comprehensive engineering design and maintenance support for improving effectiveness and testability of new and existing designs

Design-For-Test (cont.)

Tool Name	Supplier	Description
VTM:TOP	Mentor Graphics	Enables design and test engineers to take maximum advantage of the observability and controllability provided by boundary-scan devices on electronic assemblies that have a mix of boundary-scan and conventional technologies
PTM:SITE		Inserts test points on MCM Station using results from VICTORY
FASTSCAN		Inserts scan chains at the IC level and generates test vectors
QuickGrade		Fault grading
ASSET Diagnostic System	ASSET, Inc.	Supports the interactive debug and test of IEEE 1149.1-component designs
ASIC Test Tool Suite	LV Software	Provides a complete test strategy for complex structured custom ASICs
STAT	Detex Systems	Function Dependency Modeling software which allows automatic development of consistent and correct diagnostic information
Test Strategy Diagram	Lockheed Martin ATL	Graphical construct which describes how flaws and faults are handled by a set of assigned means
SCANease	National Semiconductor	Alternative to ASSET Diagnostic System Tools
STARS	MSI Systems	STARS generates a model base for a system which provides diagnostic analysis capability and repair recommendations
Economic Modeling Tools	Test Economic Services	Presents a comparison of board/ASIC costs based upon entry of board/ASIC/design details with special emphasis on ATE and BScan DFT
Voyager FS	IKOS	Fault simulation
Fault Simulation Accelerator	ZYCAD	Hardware accelerated fault simulator with interface to QuickSim II simulator

Enterprise System

Tool Name	Supplier	Description
AIM	Intergraph	Product Data Manager
DMM		Design Methodology Manager
MS Project	Microsoft	Project planning and scheduling tool
Netscape Enterprise Server	Netscape	Provides secure communication and browsing capabilities over the Internet
PGP	Viacrypt	Allows users to ensure that their messages are read only by intended recipients by using public key encryption
Work Expert	Mentor Graphics	Used to execute workflows to automate tasks
Communiqué and Cooltalk	Insoft	Supports a wide variety of information exchange mechanisms to support collaborative work
Explore (CLMS)	Aspect	RASSP design component info system
Manufacturing Interface (MI)	SCRA	A standards based capability to perform design-for-manufacturing analysis and perform data translations between design and manufacturing tools
ProSim	KBSI	Process modeling product that enable users to capture, document, and analyze processes

Enterprise System (cont.)

Tool Name	Supplier	Description
RRRDM/IIB	Sandpiper Software	Intelligent Information Broker (IIB) provides capability to search stored meta-data for design data
WITNESS	AT&T	A process simulation tool
TriTeal Enterprise Desktop (TED)	TriTeal	A graphical desktop environment that provides independence from the underlying operating system and hardware